

(ON) SI — BOLA EXTRA — NO
 (ON) SI — PREMIO LOTERIA — NO
 SI — RECLAMO — NO

PARTIDAS / MONEDA }
 3 — BOLAS PARTIDA — 5
 PREMIOS / PUNTOS }

(ON) SI — VISUALIZAC. H. FUNCION. — NO
 (ON) SI — VISUALIZAC. MONEDEROS — NO
 (ON) SI — VISUALIZAC. PARTIDAS — NO

CON. E

16 — RESET OUT
 15 — TILT
 14 — INICIO PARTIDA
 13 — MONEDA PEQUEÑA
 12 — MONEDA MEDIANA
 11 — MONEDA GRANDE

7 TAPON

5 — TR1
 4 — R1
 3 — TOT. PEQ. TR2 R2
 2 — TOT. MED. TR3 R3
 1 — TOT. GRAN. TR4 R4

10 — FU. SE1

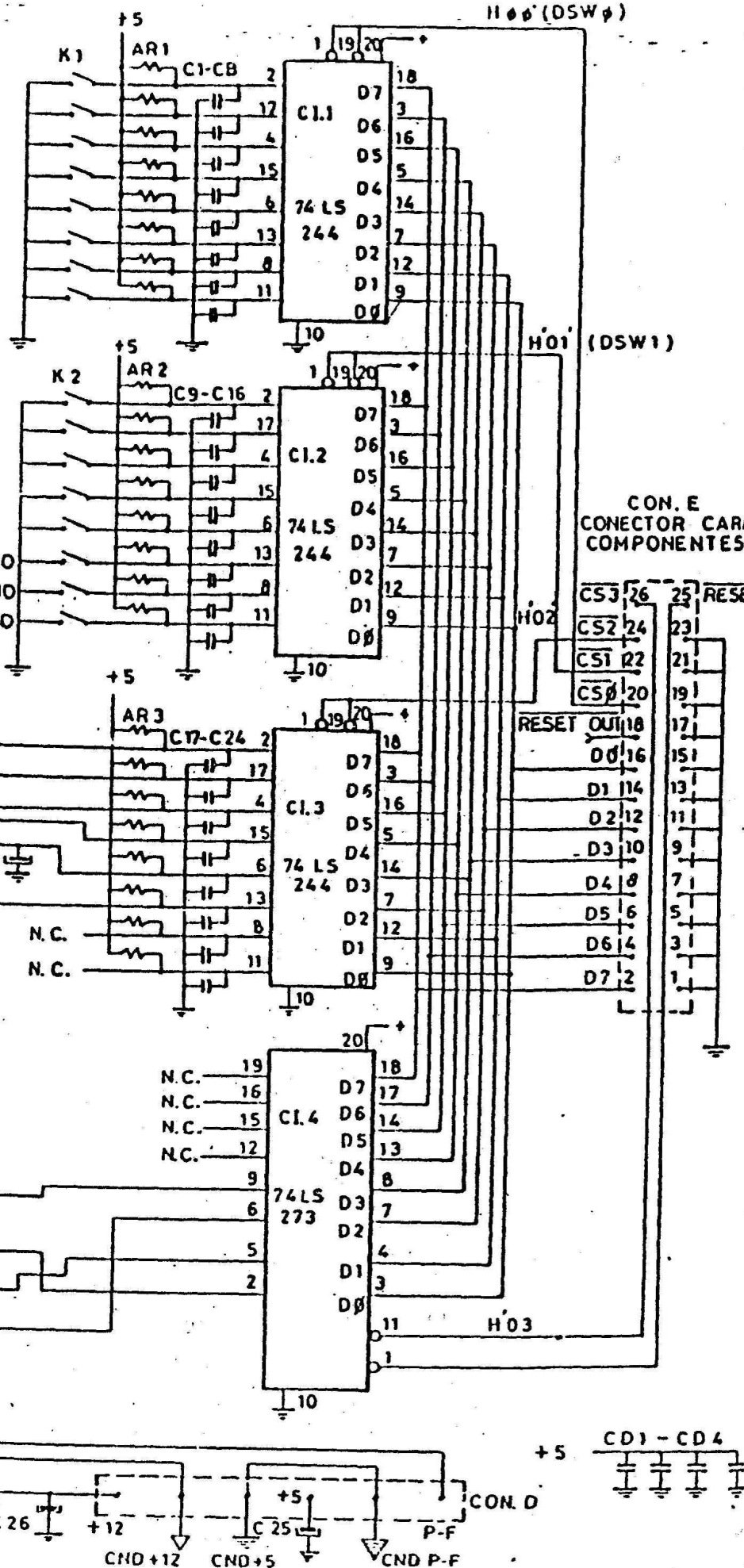

CON. E
 CONECTOR CARA
 COMPONENTES

CS3 26 25 RESET
 CS2 24 23
 CS1 22 21
 CS0 20 19

RESET OUT 18
 D0 16
 D1 14
 D2 12
 D3 10
 D4 8
 D5 6
 D6 4
 D7 2

H01 (DSW1)
 H02
 H03

+5 CD1 - CD4

CND +12 CND +5 CND P-F

PLACA DE ENTRADAS

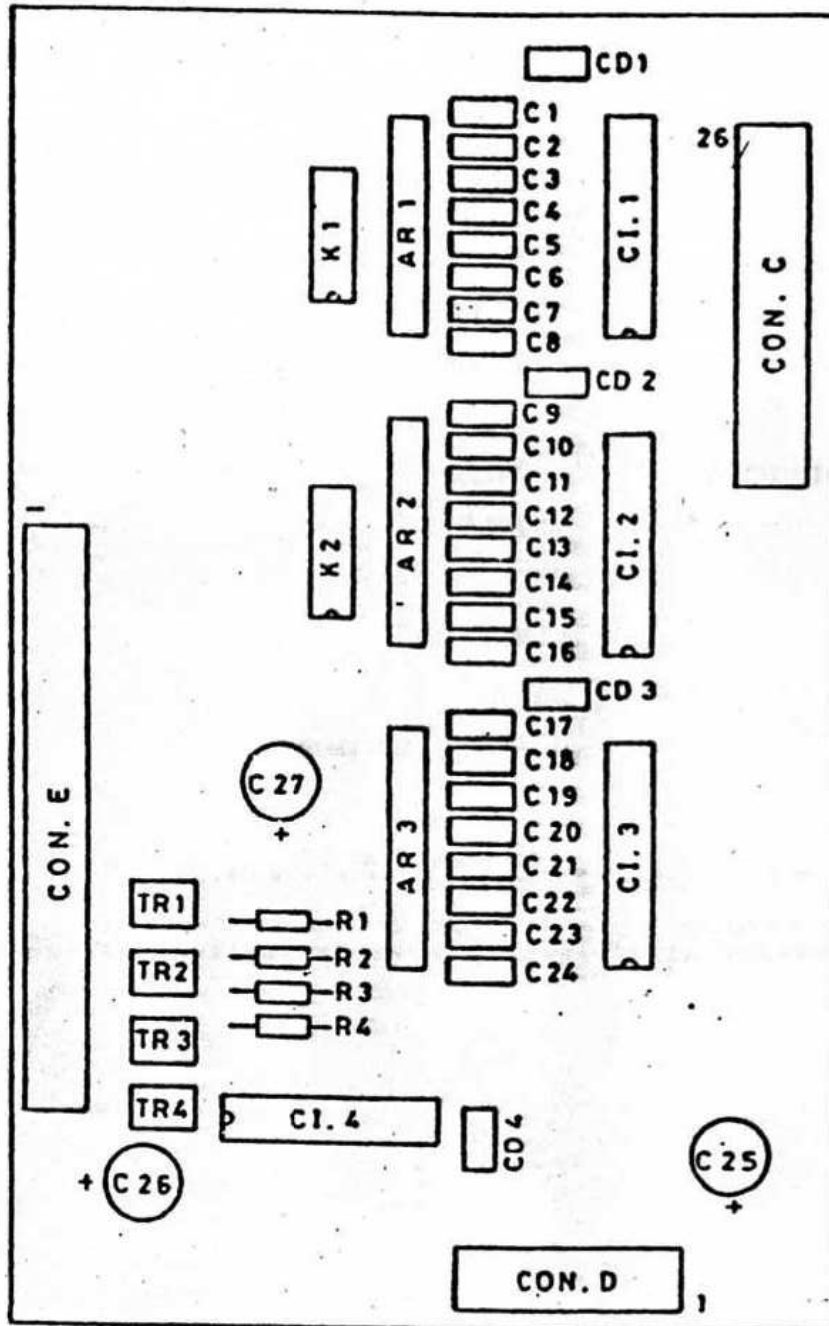

CAR
TES
RESEI

COMPONENTES

PLACA ENTRADAS

TIPO	VALOR	SITUACION
Resistencia	330 ohm. 1/4w.	R-1/4
Condensador	1 nF. 16v.	C-1/24
	220 nF. 25v.	C-25,26
	47 nF. 25v.	C-27
	100 nF. 16v.	C-1/4
Circuito integrado	74LS244	CI-1/3
	74LS273	CI-4
Transistor	MPS-A12	TR-1/4
Array	4K7 9 pins	AR-1/3
Dip-switch	8 posiciones	5A-8515-8

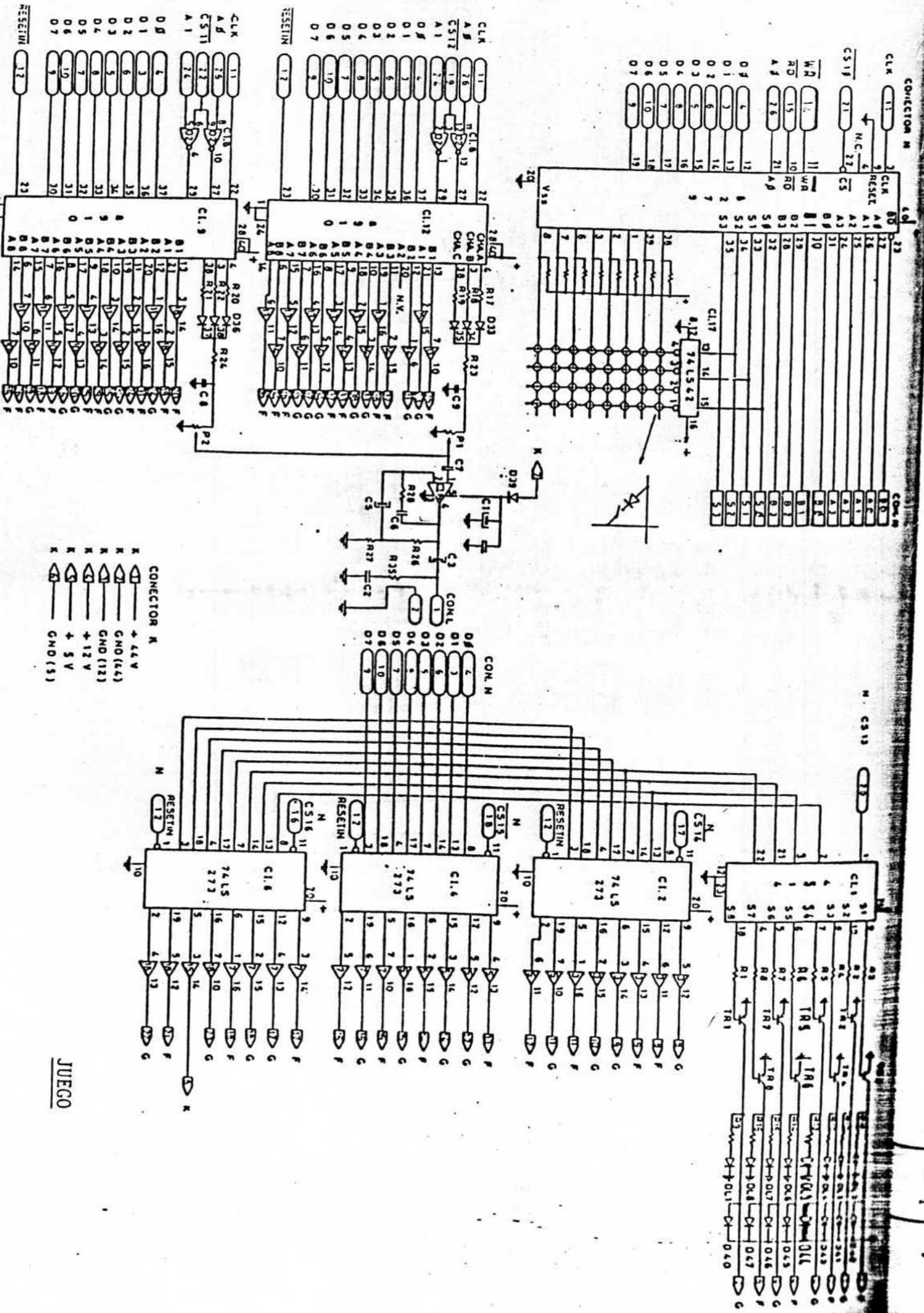

JUEGO

CON K

DL 20
DL 21
DL 22

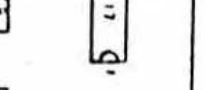
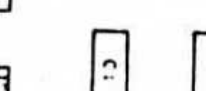
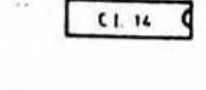
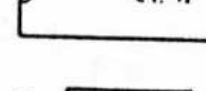
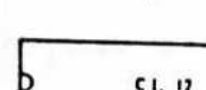
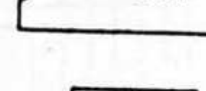
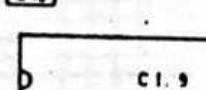
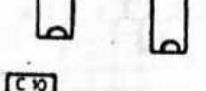
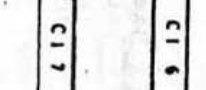
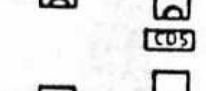
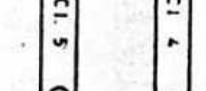
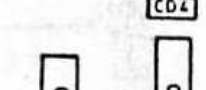
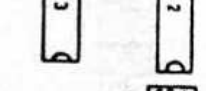
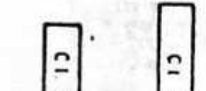
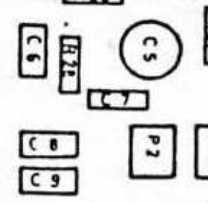
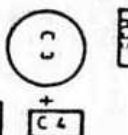
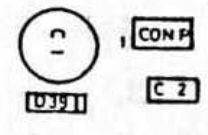
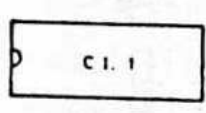
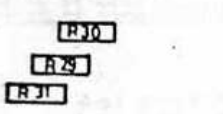
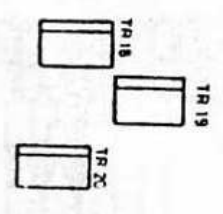

CON M

CON N

CON L

CON F

CON J

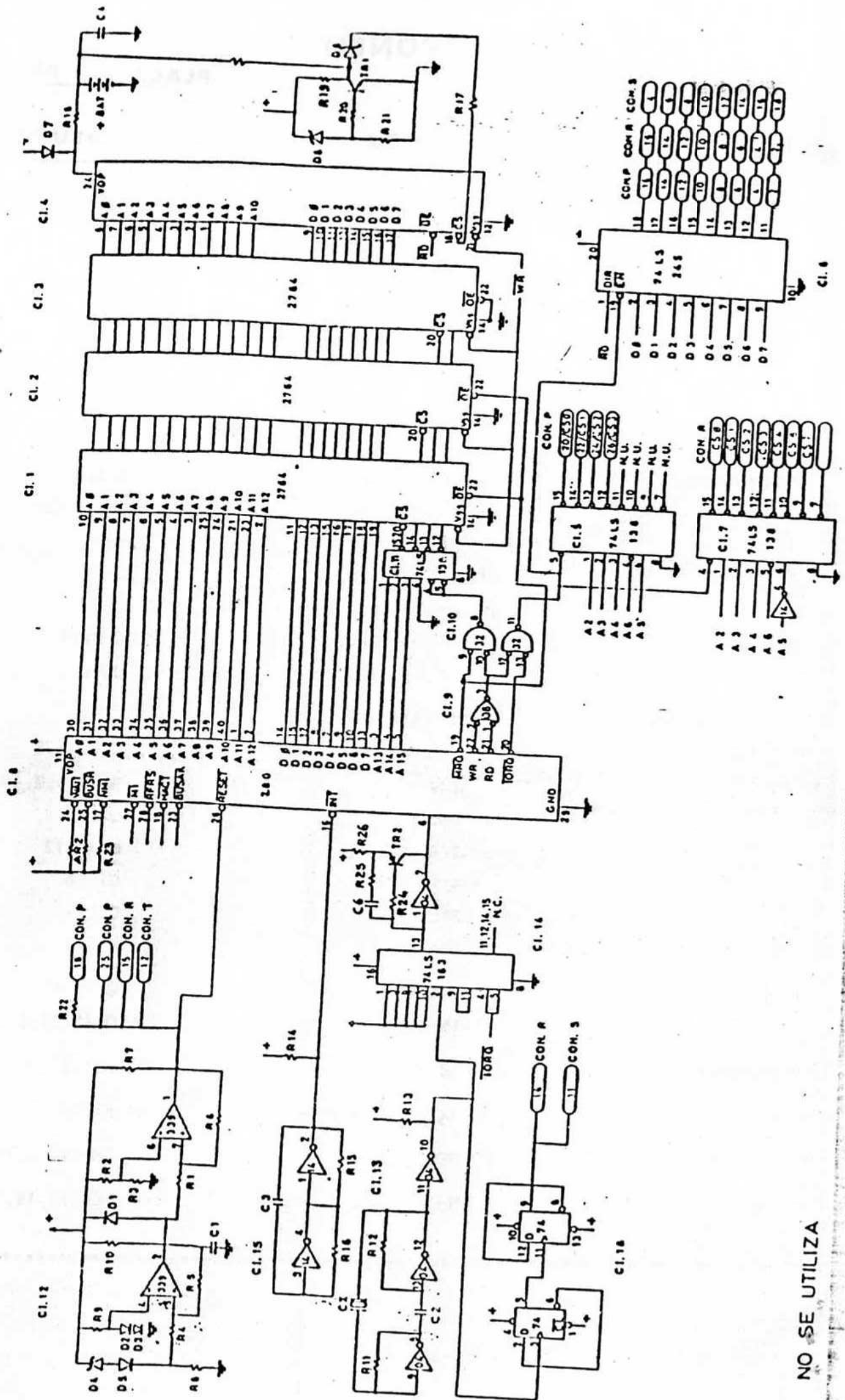

NO SE UTILIZA

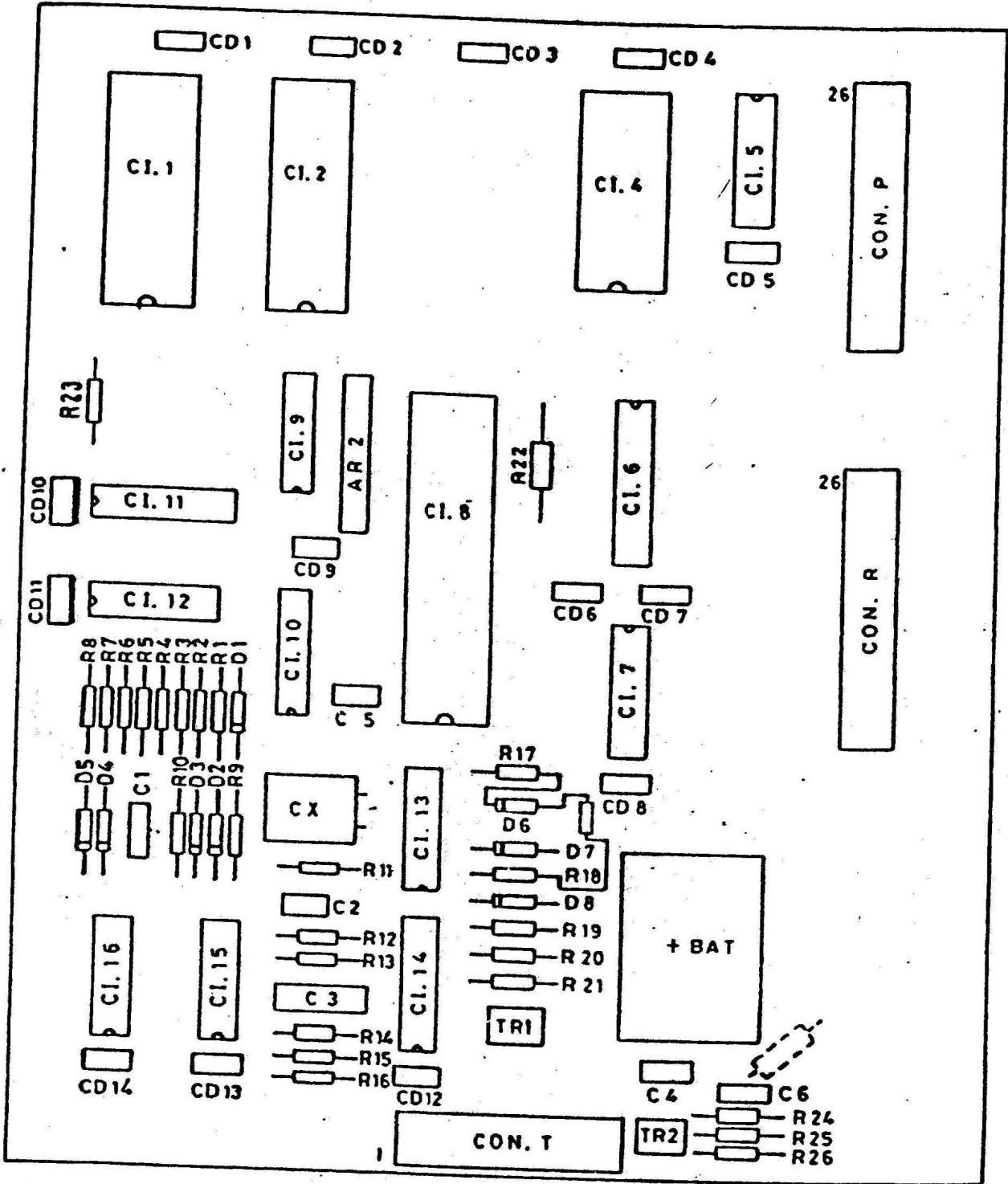

COMPONENTES

PLACA C.P.U.

TIPO	VALOR	SITUACION
------	-------	-----------

Resistencia	330 ohm. 1/4w.	R-24
	22 ohm. 1/4w.	R-26
	56 ohm. 1/4w.	R-18
	470 ohm. 1/4w.	R-19/21,23
	82 ohm. 1/4w.	R-22
	220 ohm. 1/4w.	R-25
	220 K. 1/4w.	R-1,4
	100 K. 1/4w.	R-2,3
	10 K. 1/4w.	R-7
	1 K. 1/4w.	R-8,9
	2K2 1/4w.	R-11,12,17
	1K2 1/4w.	R-13/16
	1K8 1/4w.	R-....
	4K7 1/4w.	R-27
	4M7 1/4w.	R-5,6
	1 M. 1/4w.	R-10
	Circuito integrado	2764
6116		CI-4
74LS138		CI-5,7,11
74LS245		CI-6
Z-80B		CI-8
74LS32		CI-9
74LS08		CI-10
LM339N		CI-12
74LS04		CI-13
74LS163		CI-14
74LS14	CI-15	
74LS74	CI-16	
Condensador	47 nF. 16v.	C-1
	1 nF. 16v.	C-2
	0'68 μ F. 16v.	C-3
	100 nF. 16v.	C-4.CD-1/15
	56 pF. 16v.	C-5
	35 pF. 16v.	C-6

.....>

COMPONENTES

PLACA C.P.U.

TIPO	VALOR	SITUACION
Cristal cuarzo	10 MHZ	CX
Diodo	1N4148	D-1,2,3,5,6
	2V7 Zener	D-4
	3VS Zener	D-8
	1N4004	D-7
Transistor	2N3904	TR-1
	2N3906	TR-2
Array	2K2 9 pins	AR-2
Bateria	3'6 v. Emerich	BT-5A-9296

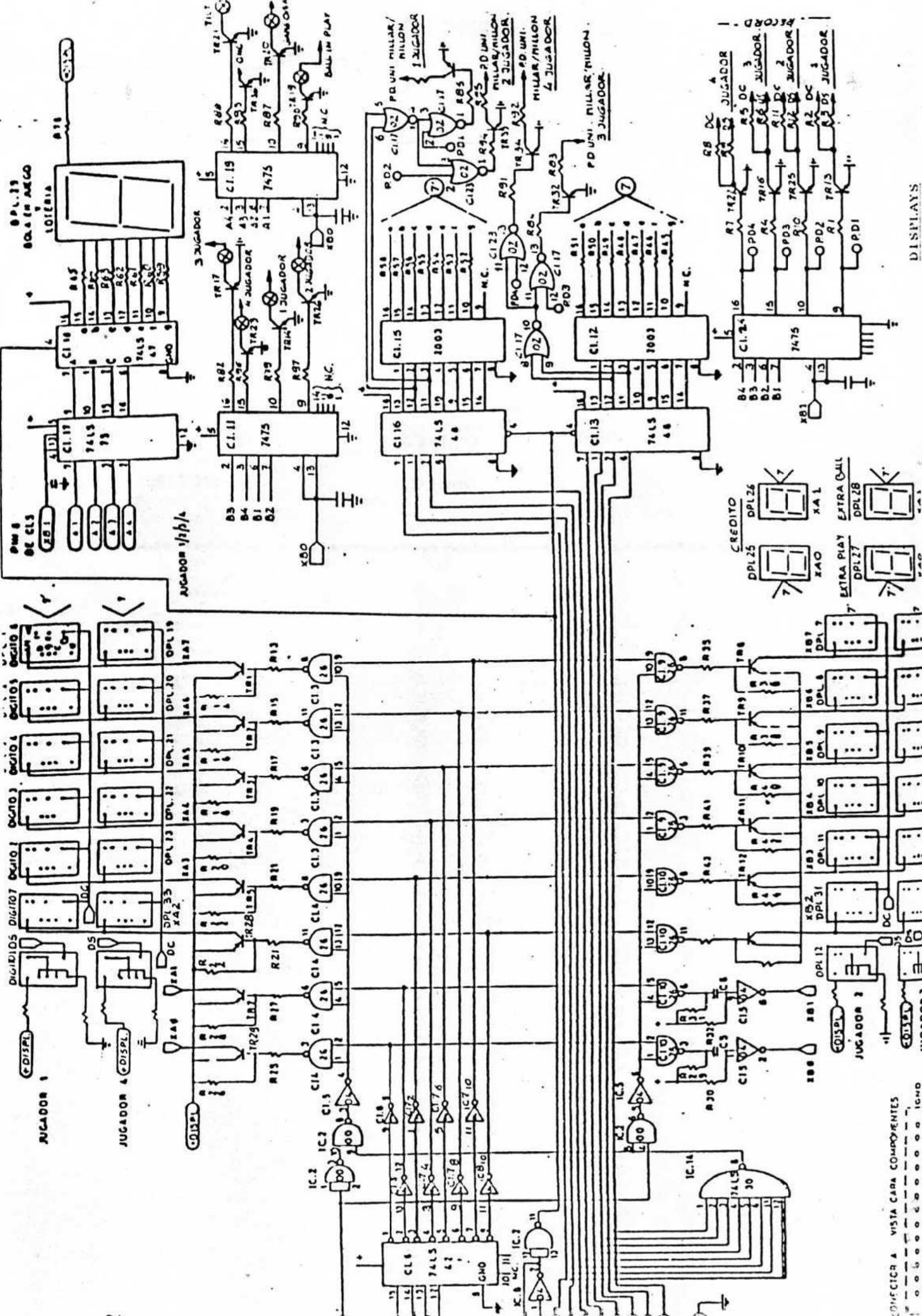

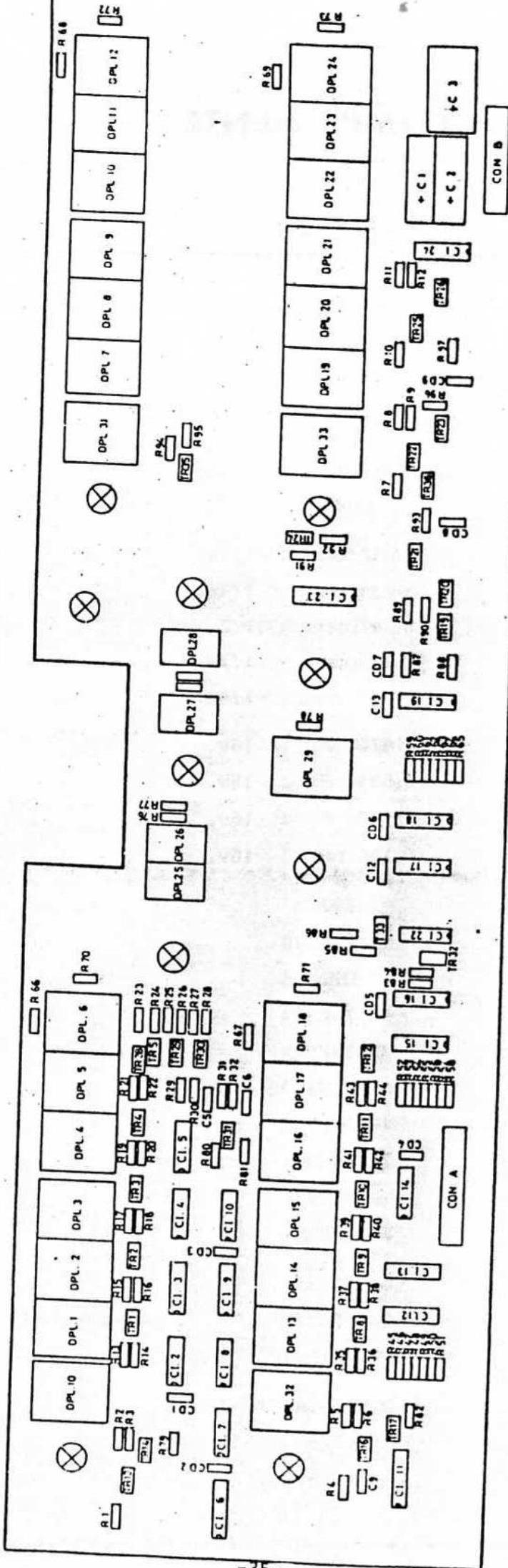

PLACA DISPLAYS 5A-8289-1

COMPONENTES

PLACA DISPLAYS

TIPO	VALOR	SITUACION
Resistencia	560 ohm. 1/4w.	R-1, 4, 7, 10, 84, 85, 91,
	5'6 ohm. 1/4w.	R-2, 5, 8, 11
	100 ohm. 1/4w.	R-3, 6, 9, 12, 83, 86, 92,
	1 K. 1/4w.	R-13, 15, 17, 19, 21, 23,
		27, 35, 37, 39, 41, 43,
	3K9 1/4w.	R-14, 16, 18, 20, 22, 24,
		28, 29, 32, 36, 38, 40,
		44, 81
	10 ohm. 1/4w.	R-45/58
	33 ohm. 1/4w.	R-59-65
	47 ohm. 1/2w.	R-66/73
	150 ohm. 1/2w.	R-78
	330 ohm. 1/4w.	R-79, 82, 87, 88, 90, 93,
		97
Condensador	470 mF. 16v.Al dorso.
	1.000 mF. 16v.Al dorso.
	10 nF. 16v.	C-9, 12, 13, 14
	100 nF. 16v.	CD-1/9, 5, 6
Circuito integrado	7475	CI-11, 17, 19, 24
	74LS00	CI-2
	DM7426	CI-3, 4, 9, 10
	74LS04	CI-5, 7, 8
	74LS42	CI-6
	ULN2003	CI-12, 15
	74LS48	CI-13, 16
	7430	CI, 14
	7447	CI-18
	74LS02	CI-22, 23
Transistor	BC636	TR-1/5, 8/12, 28/31
	SG107B	TR-13, 16, 22, 25, 32/35
	MPS-A12	TR-14, 17, 19/21, 23, 26,
Displays	LTS3401AE-1	DPL-1/24, 29/33
	LTS3731E-1	DPL-25/28
Lamparita Por talamparas	6v. 2w.	24A-9956
	-	24A-9966

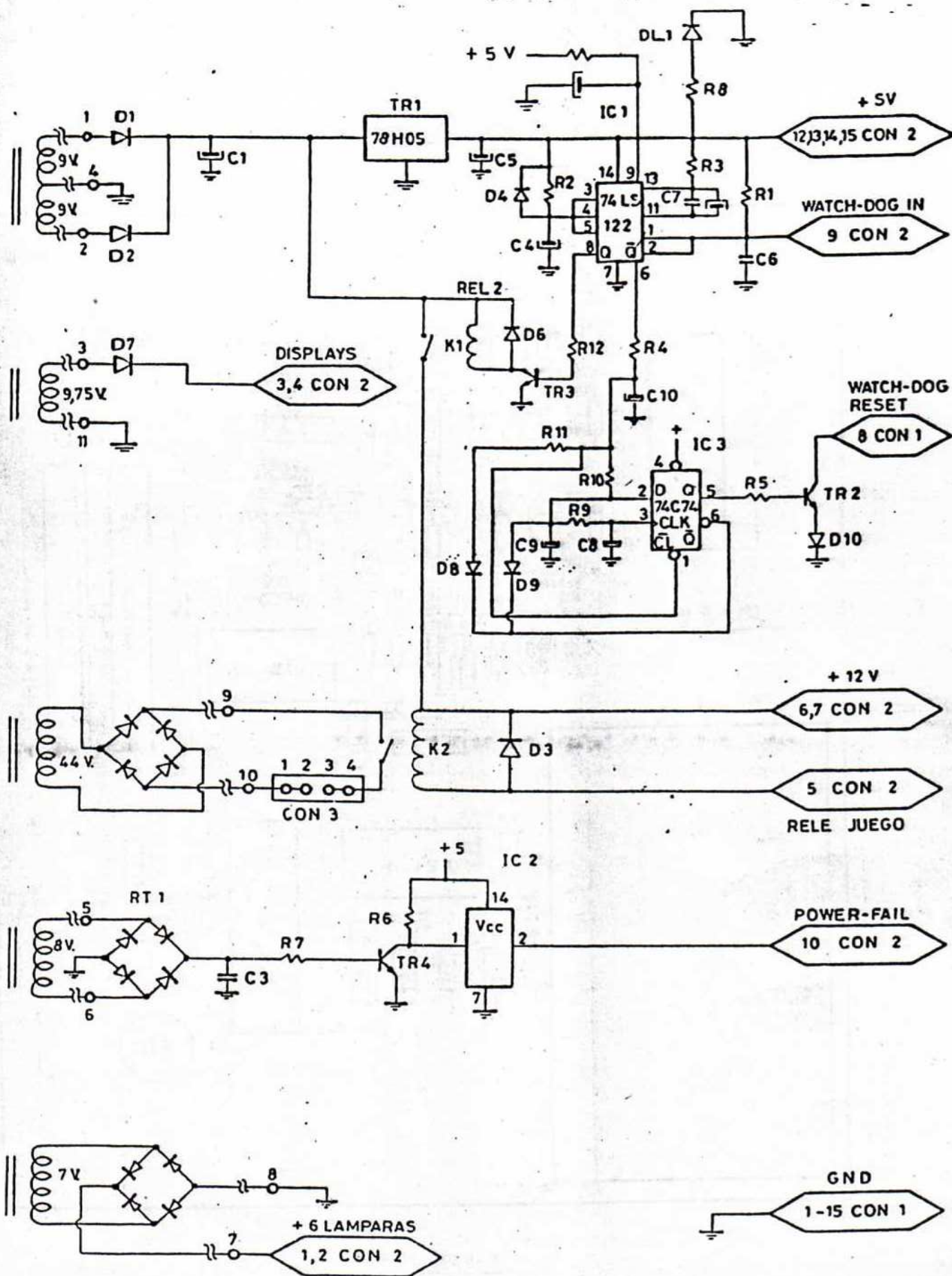

FUENTE DE ALIMENTACION

PLACA FUENTE DE ALIMENTACION

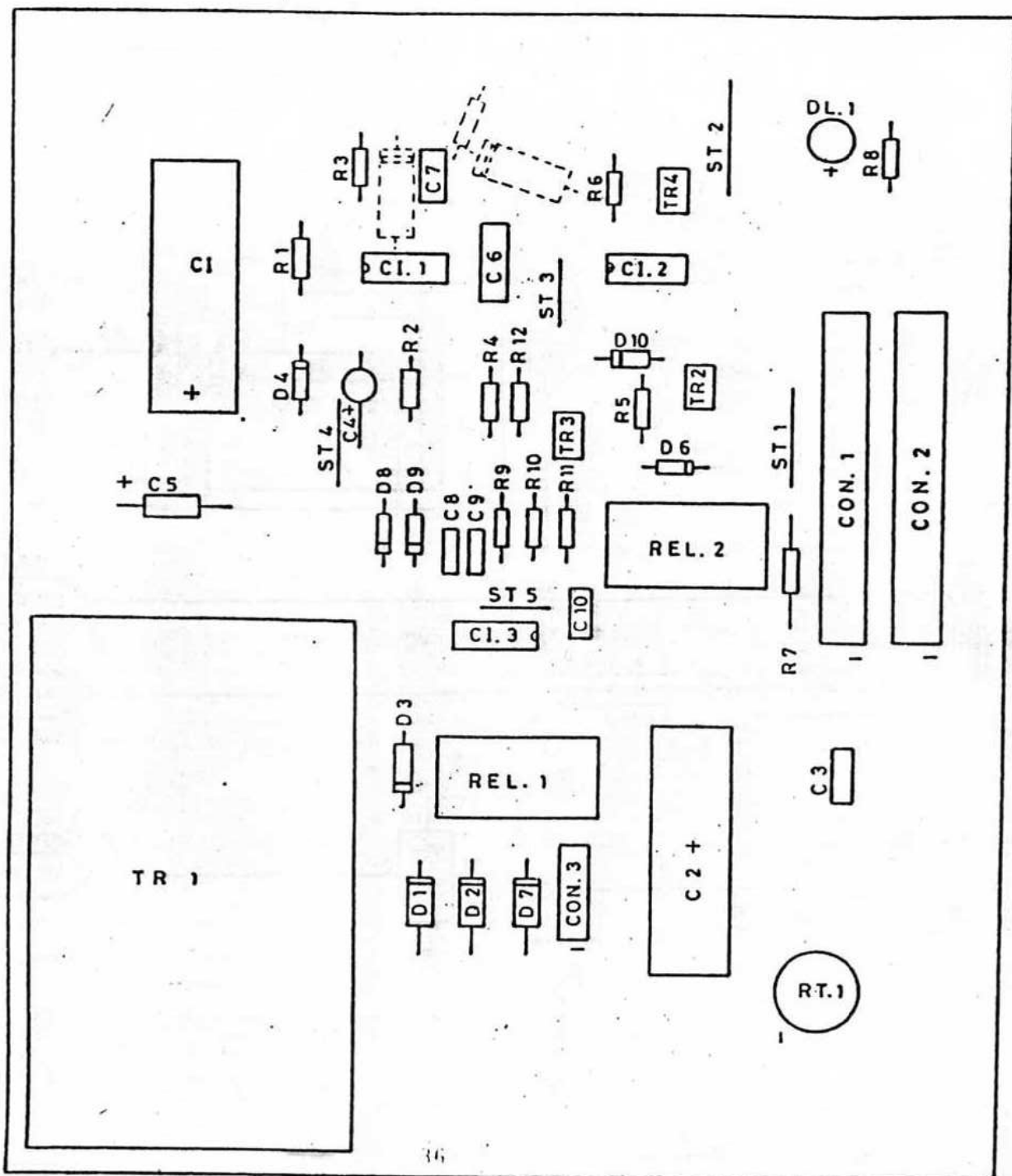

5A-8290

1	2	3	4	5	6	7	8
						ON	ON
						ON	OFF
						OFF	ON
					ON		
					OFF		
			ON	ON			
			ON	OFF			
			OFF	ON			
			OFF	OFF			
		ON					
		OFF					
	ON						
	OFF						

FUNCIONES	
1ª PARTIDA EXTRA 2.000.000 / 2ª PARTIDA EXTR 2.600.000	
1ª PARTIDA EXTRA 2.500.000 / 2ª PARTIDA EXTR 3.100.000	
1ª PARTIDA EXTRA 3.000.000 / 2ª PARTIDA EXTR 3.600.000	
1ª PARTIDA EXTRA 3.500.000 / 2ª PARTIDA EXTR 4.100.000	
3 BOLAS / PARTIDA	
5 BOLAS / PARTIDA	
1 x 25 PTS - 1 PARTIDA	1 x 100 PTS - 5 PARTIDAS
1 x 25 PTS - 1 PARTIDA	1 x 100 PTS - 6 PARTIDAS
1 x 25 PTS - 2 PARTIDA	1 x 100 PTS - 8 PARTIDAS
2 x 25 PTS - 1 PARTIDA	1 x 100 PTS - 3 PARTIDAS
NO MUSICA RECLAMO EN REPOSO	
SI MUSICA RECLAMO EN REPOSO	
NO LOTERIA	
SI LOTERIA	

COMPONENTES

PLACA FUENTE ALIMENTACION

TIPO	VALOR	SITUACION	
Resistencia	330 K. 1/4w.	R-4,10	
	100 K. 1/4w.	R-9	
	1 K. 1/4w.	R-1,6,12	
	1 M. 1/4w.	R-3	
	1K2 1/4w.	R-5	
	12 K. 1/4w.	R-7	
	10 K. 1/4w.	R-2	
	3K9 1/4w.	R-11	
	220 K. 1/4w.	R-13	
	330 ohm. 1/4w.	R-8	
	Condensador	4700 mF. 25v.	C-1,2
		0'68 mF. 100v.	C-3
		470 mF. 25v.	C-4
10 mF. 25v.		C-5,8,9,10	
1 nF. 16v.		C-6	
0'33 mF. 250v.		C-7	
22 mF. 25v.		C-11,12	
Circuito integrado	74LS122	CI-1	
	74LS14	CI-2	
	74C74	CI-3	
Transistor	BC635	TR-2,3,4	
Regulador	8506	TR-1	
Diodo	BY214	D-1,2,7	
	1N4004	D-3,6,10	
	1N4148	D-4,8,9	
Led Rojo	-	DL-1	
Relé	1 ctº. 170 ohm. 6 amp.	REL-1,2	

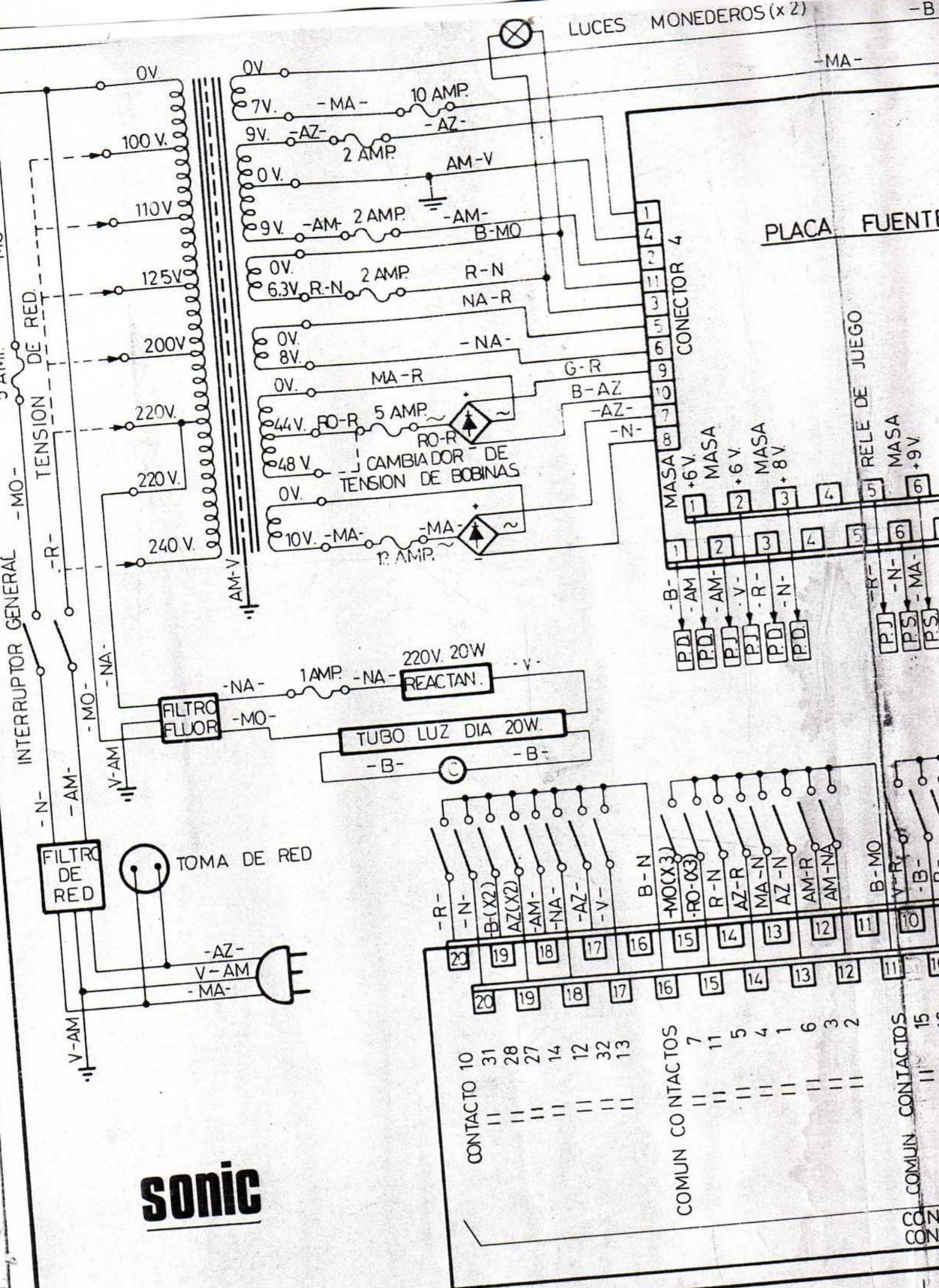

sonic

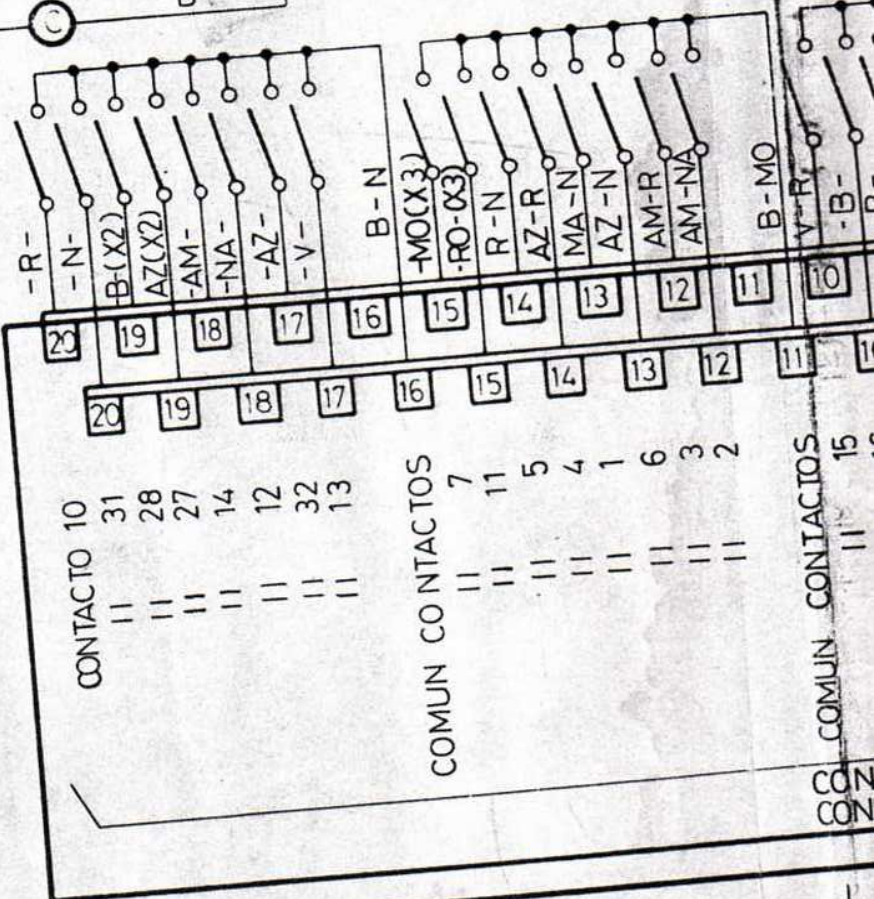

MA-

FUENTE ALIMENTACION

P.F

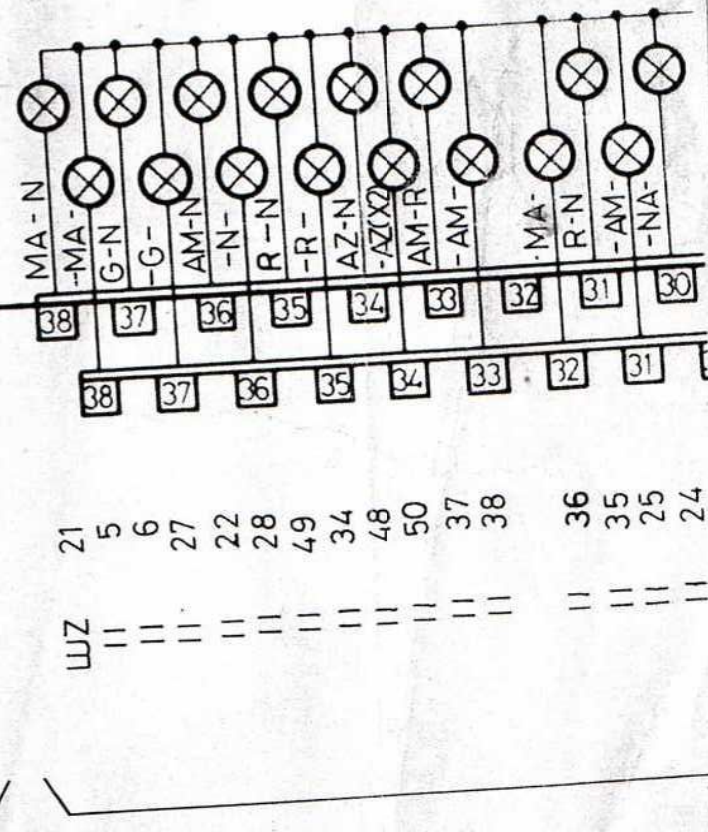
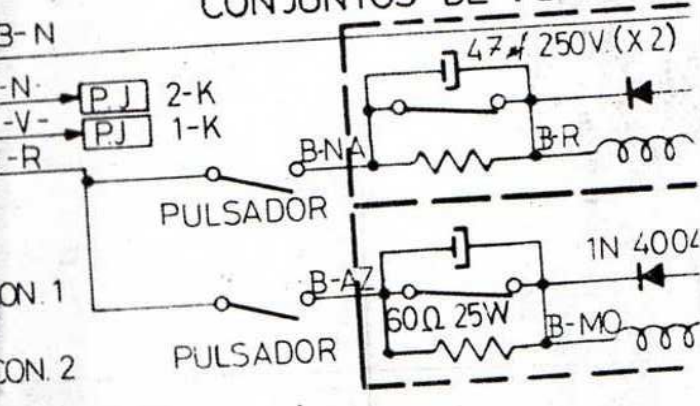
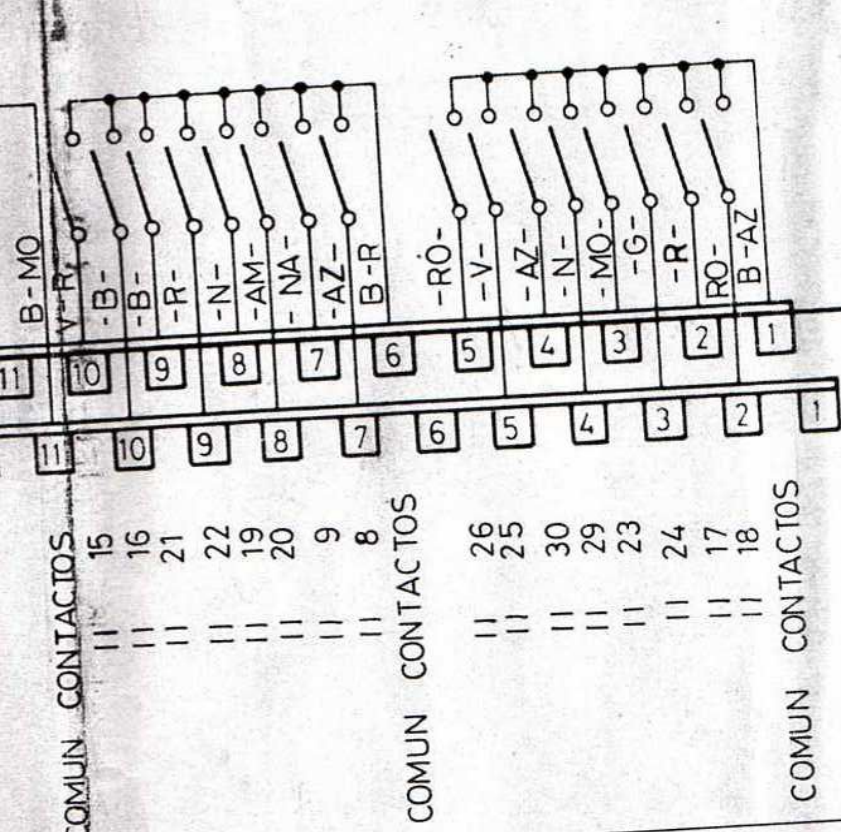
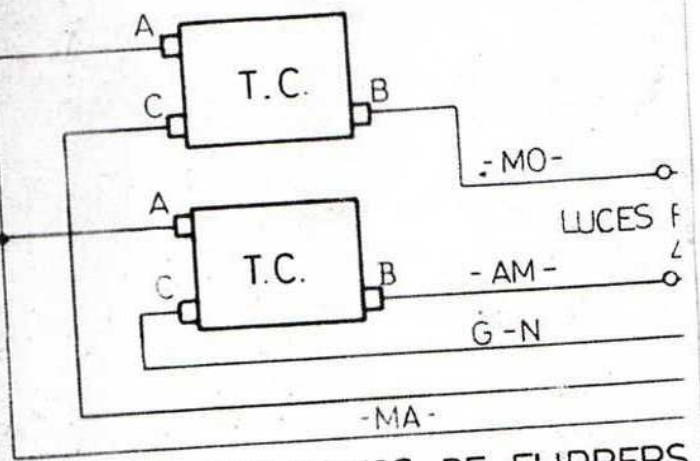
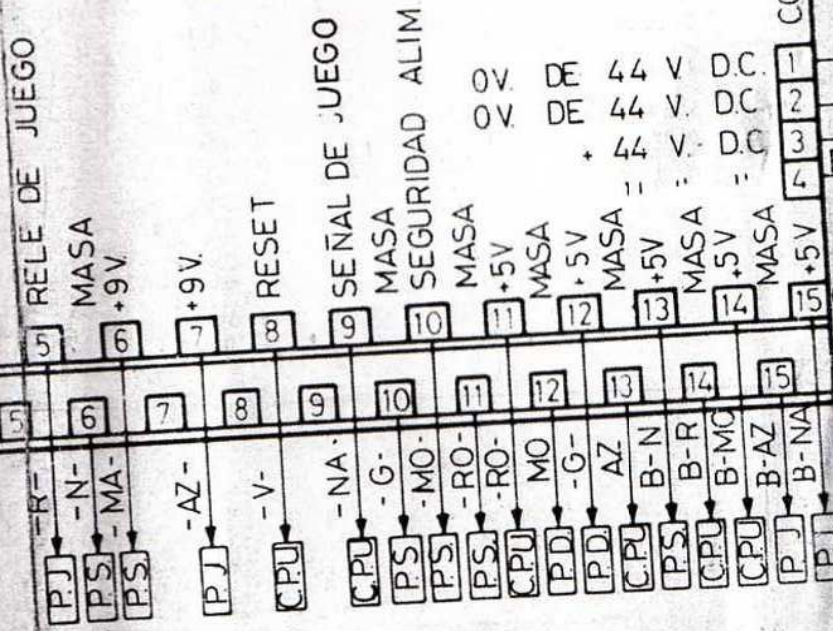

CONECTOR CONECTOR J H

