

# INSTRUCTIONS MANUAL AND

## TROUBLESHOOTING

# SPACE GAMBLER

**PLAYMATIC s.a.**

**BARCELONA - 16**

**SPAIN**

**TUCUMAN 26-28**

**phone: 3458504**

### I N D E X

- INTRODUCTION	Page -2-
- GENERAL INSTRUCTIONS	" -3-
- GAME ADJUSTMENTS	" -6-
- DETAIL OF THE ELECTRONIC COMPONENTS USED IN THE MACHINE	Page -11-

#### TROUBLESHOOTING

1.- RELAYS MODULE Components used	Page -16-
2.- CONE MODULE Components used	" -18-
3.- THYRISTORS MODULE Components used	" -21-
4.- BELLS MODULE Components used	" -23-
5.- DISPLAYS MODULE Components used	" -26-
6.- DECODER MODULE Components used	" -30-
7.- CREDIT AND MATCH FEATURE MODULE Components used	" -39-
8.- MPU MODULE Components used	" -42-

GAME BOARD

ENGINEERING DRAWINGS

TECHNICAL CHARACTERISTICS OF THE DIFFERENT ELECTRONIC COMPONENTS

## I N T R O D U C T I O N

The machine SPACE GAMBLER Solid State System has been designed employing the new technique of MICRO-PROCESSORS. Such a system has numberless advantages as: High reliability, absence of interferences and spectacular reduction of necessary components. All that reduces infinitely the failure probability.

For more versatility, easy failure and common stock pieces location in the distinct models of machines, the electronic circuits unit has been divided into different modules:

### 1.- RELAYS MODULE

Its function consists on driving current to the distinct electromagnets necessary for the play and cutting the current to these electromagnets in case of Tilt or Game Over.

### 2.- CONE MODULE

Has as function lighting the six cone stages.

### 3.- THYRISTOR MODULE

Its function consists in controlling the different lights that are to be lighted during the play.

### 4.- BELLS MODULE

Its function is transforming and amplifying some voltage impulses to the different frequencies that are characteristic for each note.

### 5.- DISPLAYS MODULE

Has as function to visualize in digital form the score of the players.

### 6.- DECODER MODULE

Its work consists in helping the MPU module to control bells, cone, displays and relays module.

### 7.- CREDIT AND MATCH FEATURE MODULE

Has as function to visualize, in digital form, the credit and match features.

### 8.- MPU MODULE

Its work consists in receiving information from the different contacts of the machine, processing this information and using it to govern the distinct modules.

When you receive the machine, or, after a long time (two months), without using it, and you connect the machine, it is possible that some numbers of the displays do not turn on and that the credit shows a number different from zero. You must make the necessary adjustments in order to put the machine ready for playing and the problem will be solved.

All the MPU inputs and outputs have voltages around 5V, but at very high frequencies. Because of that, it is impossible to measure them with a normal voltmeter.

All the wires that go in and out the MPU have a series resistors to limit the maximum shortcircuit current.

Due to the small intensity that goes through the wires going in and out the MPU, it can be derived to ground through the human body when touching a wire. It is absolutely normal and it does not affect the normal operation of the machine.

For better operation of the electronic part of the machine a special and independent wiring has been made in the supply transformer. Try, naturally, to avoid short-circuits with any other winding.

Be always sure not to apply more than the correct voltage to MPU. If higher voltage is applied, an internal protection circuit will operate blocking the machine. The symptoms that will be produced are: none of the lights will turn on, the digital counters for credit and match feature will be off and the displays will keep the same scores without appearing the SCORE TO DAY.

The 3 Amp.fuses, that feed the lamps, have been calibrated to blow in case of shortcircuit in a lamp socket. So, do not use fuses of a higher value, since the diode and the thyristor could get damaged, instead of blown the fuses.

All the contacts that are placed on the playfield, form a matrix. Due to this configuration, there are five common conductors and always only one of them will have current. First conductor A, afterwards B, then C, D and finally E. And the cycle will be repeated.



When the machine is in Game Over, the cycle will be between A and B. At the beginning of the play the whole cycle will occur.

With this matrix location, it is easy for MPU to know which is the closed contact, since MPU knows which column, by the moment, has current and also through which input returns the current. If anyone of the contacts remain closed, MPU is programmed to overlook it and to act as if that contact were always open.

The information, which is visualized on the displays, is refreshed 30 times in a minute, because it could be lost due to the interferences. This is the reason why we will see the test lamp blinking, when we test the command signals L1 to L8 with the test point.

For checking and in case of failure, it is possible to make bridges to positive or to negative. It is important, when making these bridges, not to make them directly from the inputs or the outputs of an integrated circuit or from the base of a transistor, but always through a resistor, that normally is connected to them.

Example:

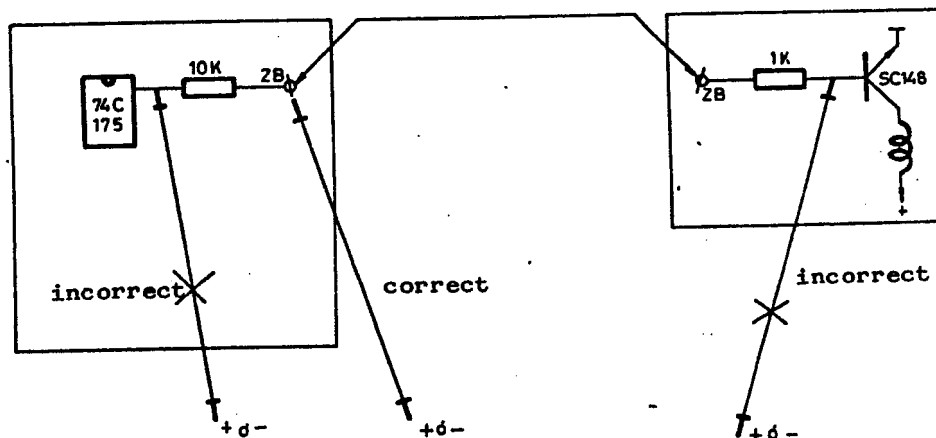

IMPORTANT REMARK

In the preseries the memories used are EPROM. For supply they need special voltages: +5 VDC  $\pm$  0,5 V at pins 24 (This is the same voltage supply for the integrated circuits placed in the module), +12 VDC  $\pm$  0,5 V at pins 19; -5 VDC  $\pm$  0,5 V at pins 21.

In the series the memories will be ROM and for them no special voltage supply is needed. In these machines the supply voltage will be + 10 VDC  $\pm$  0,5 V, just the same as the voltage used for integrated circuits. In these machines the components used for the special voltages will be suppressed.

The troubleshootings in the MPU module are explained for the preseries machines, that means, with voltages + 5V, +12V and - 5V. For the rest of the series it will be easy the interpretation by changing + 5V by + 10V.

In the DECODER module and for the preseries there have been used integrated circuits LM 324, whose function is to raise the voltage level from 5 volts coming from MPU to 10 volts which is the voltage of duty at DECODER module. When the memories are ROM all these circuits will disappear since the duty voltages in MPU and DECODER module are the same.

### GAME ADJUSTMENTS

At the moment of connecting the machine to the voltage line, at the credit and match feature counters, the numbers 1 to 6 will appear. These numbers correspond to the test which verifies the MPU module. When the machine is at the Game Over state, there is a continuous movement of the lights on the board. It is at this moment that the adjust or control push buttons, as described below, can be operated.

- 1.- Push-button 1 M (Located at the coin door)  
When pushed, the number of coins, that have passed through the first coin selector, is visualized at the first player display. After two seconds this information is erased although the button is still pushed. To visualize the number of coins again, it is necessary to push the button once more.
- 2.- Push-button 2 M (Located at the coin door)  
When pushed, the number of coins, that have passed through the second coin selector is visualized at the first player display. After two seconds this information is erased although the button is still pushed. To visualize the number of coins again, it is necessary to push the button again.
- 3.- Push-button 3 M (Placed at the coin door)  
When pushed, the number of coins, that have passed through the third coin selector is visualized at the first player display. After two seconds this information is erased although the button is still pushed. To visualize the number of coins again, it is necessary to push the button once more.
- 4.- Push-button Credit by coins (Placed at the coin door)  
When pushed, the total number of coins by credit, that have passed through any of the coin selector, is visualized at the first player display. After two seconds this information is erased although the button is still pushed. To visualize the number again, it is necessary to push the button once more.

- 5.- Push-button Credit by Awards (Placed at the coin door)  
When pushed the credit, that the players have reached by Special, points, "High Score" and Match feature is visualized at the first player display. After two seconds this information is erased although the button is still pushed. To visualize this number again, it is necessary to push the button once more.
- 6.- Push-button Set to Zero (Placed at the light box)  
When pushing this button, the information contained in memories of push-buttons 1,2,3,4 and 5 is set to zero. It also sets to zero the credit counter.
- 7.- Push-button first credit-by score (points)  
(Placed at the coin door)  
When pushed, it is visualized at the first player display at which score will be given the first credit. If the button continues pushed, after two seconds, the score will begin to raise by adding 10,000 points each two seconds. When the desired score is reached, leave the button free. If not desired to give any credit by score, set the score to 000,000.
- 8.- Push-button second credit by score (Placed at the coin door)  
When pushed, at the first player display is visualized at which score will be given the second credit. If the button continues pushed, after two seconds, the score will begin to raise by adding 10,000 points each two seconds. When the desired score is reached, leave the button free. If desired not to give any credit by score, set the score to 000,000.
- 9.- Push-button third credit by score (Placed at the coin door).  
When pushed, at the first player display is visualized at which score will be given the third credit. If the button continues pushed, after two seconds, the score will begin to raise by adding 10,000 points each two seconds. When the desired score is reached, leave the button free. If desired not to give a third credit by score, set the score to 000,000.

10.- Push-button High Score (Placed at the coin door)

When pushed at the first player display is visualized at which score will be given the High Score award. If the button is maintained pushed, each two seconds the score will raise by adding 10,000 points. When the desired score is reached, leave the button free.

The High Score award is given by the machine when a established score is surpassed in 100, 1,000 or 10,000 points. Once reached the High Score award will be given when another player surpasses the score of the player that reached the award.

When a player reached the score of High Score, the machine will give him three credits, a special music will sound and a frontal light, that shows "Score to Day", will turn on. This light indicates that a player has surpassed the highest score and if another player wants to get the High Score award he has to beat him.

If desired to disable the "High Score" award, it is enough to set the necessary score to 999,000.

Example:

High Score regulation: 450,000

A player surpasses it with the second ball 450,100  
SCORE TO DAY

at Game Over this player has a score of 465,300  
SCORE TO DAY

Now the High Score regulation will be on 465,300 points.

To be known by the other players at which score is the High Score award, the number will be appearing at the first player display while the machine is in Game Over.

At the same time the SCORE TO DAY light will be on.

11.- Push-button Test (Placed at the coin door)

It is used to verify the correct operation of the machine.

When the push-button is pushed, it works as explained below:

- 1/ The frontal lights are on, except those of the four players and the playfield lights, which do not operate during the light play, that take place during the Game Over, enabling so to check if there are any defective lights.

- 2/ The taca sounds, the targets appear, a ball is dispensed and also the game current supplied. So, flippers, bumpers and kickers can be operated. With this test it is possible to verify the correct operation of the electromagnets part.

- 3/ The displays of the four players have to show 8888, except the one of the first player which will show 8888?? and in the tenths and unities, the number of the contact that at that moment is closed.

The credit and Match feature counters will be at 18 and 800 respectively.

With this can be verified that the segments of the displays, credit counters and match feature do not have any defect. Now it is possible to check if there are no closed contacts, except the suede contact, which must be closed. If we open this contact for a moment, the display will show the number 00.

It is also possible to check all open or dirty contacts, moving the ball through lanes, buttons and rebounds. Each contact will force the display to show its number.

Once all the verifications are made, put the machine in Game Over manipulating the main power switch turning it on and off.

Switch 5 ball - 3 balls (Placed in the MPU module light box )

In a match 3 or 5 balls will be available depending on the state of the switch.

Switch EXTRA BALL - GAME (Placed in the light box, module MPU)

In GAME position, the credit counter will add the credits obtained through Specials, Score, High Score and Match features.

In EXTRA-BALL position, an extra ball will be available, when during the game Specials, Score awards or High Score awards have been obtained.

In this position the match feature is cancelled.

Switch second selector (Placed in the light box, module MPU)

With this commutator, the number of credits which the second coin selector will produce, when putting a coin, can be regulated. The available positions are: 1/2, 1, 3/2, 2, 3, 4, 5, 6 credits.

If we have the switch in the 1/2 position and introduce a coin, no credit will be given, but introducing a second coin a credit will appear at the counter. If we have the switch in the 3/2 position and introduce a coin, one credit will appear at the credit counter and 1/2 credit will be memorized waiting for the second coin. If in this moment we set the machine in play, the half credit will be kept until Game Over and at this moment this half credit will be cancelled.

Switch third selector (Placed in the light box, MPU module).

With this switch can be regulated the number of credits the third selector will give when introducing a coin.

The available positions are: 3,4,5,6,7,8,9 and 10 credits.

In the machines, which have installed three selectors, the first selector always gives only one credit.

#### DETAIL OF THE ELECTRONIC COMPONENTS USED IN THIS MACHINE

In the procedures of troubleshooting some methods of verifications are used:

1.- Test voltages with the voltmeter.

Having this instrument, it will be set to read continuous or alternated voltage depending on the kind of voltage we need to measure. The negative plug of the voltmeter will be connected to the negative pin of the MPU and with the positive plug the different points will be checked.

2.- Continuity test with ohmeter.

For this test, it is necessary to disconnect the machine from the voltage line. Once the machine is disconnected, continuity can be checked between the desired points.

3.- Test if TL (Test Lamp) gets lighted.

In the DECODER module a little lamp has been incorporated. This little lamp gets lighted with voltages of 2,5 V. To check if there is enough voltage in a certain point, just touch the point with the incorporated plug.

#### RESISTOR

It is a component that offers a resistance or difficulty to the pass of the current. Its function in the machine is to create a voltage drop (Bumper lights) and to limitate the current, that flows to a certain component. (Thyristor, transistor .....).

#### CAPACITOR

It is a component which stores an electrical charge and supplies this charge, when the voltage, which has produced this accumulation disappears. Its function in the machine is to provide pure continuous voltage (electrolitics) and eliminate the parasites produced in the alternated current.

#### DIODE

It is a component that only allows the pass of the current in one sense. When the anode is positive and the cathode more positive, the diode behaves as an open circuit, but if the cathode is more negative the diode behaves as a short circuit. (See fig.1)

Fig. 1

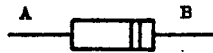

**TRANSISTOR**

The function of the transistor in these machines is called switching. (See Fig. 2)

Fig. 2

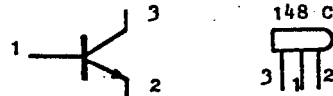

Pin 2 (emitter) is connected to the negative. Pin 3 (collector) is connected to the positive through a load (ex. coil relay). When we apply a positive current to the base (pin 1), the transistor will switch, remaining joined electrically pins 2 and 3. In this way we have the load between the positive and negative potential. When the current at pin 1 stops the transistor will be opened, leaving an open circuit for the negative potential. (See fig.4)

**THYRISTOR**

It is a controlled diode. Pin 2 (cathode) is connected to the negative potential. If we apply a potential of 1 volt with a current of .1 Ma. (0.001 A.) to pin 1 (gate), the diode will allow the pass of current, if pin 3 (anode) is positive. When the voltage in pin 3 becomes negative, the diode will stop conducting if the voltage in pin 1 has disappeared (See fig. 3).

Fig. 3

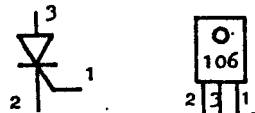

For easy comprehension we can find for the transistor as well as for the thyristor a resemblance with an electro magnetic relay of an open contact. (see fig.4)

Fig. 4

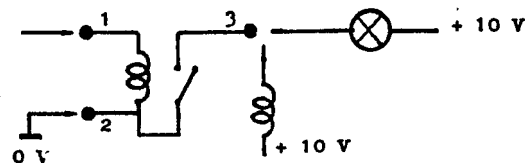

We connect coil terminal 2 to 0V voltage and also one of the little plates of the contact. Through the coil terminal 1 we apply an impulse which necessarily has to be positive. At this moment the relay remains activated, closing the contact which passes the negative potential 0V to the plate of contact 3.

**INTEGRATED CIRCUITS**

Due to the great number of electronic components (resistors, transistors, diodes...) employed in these integrated circuits, some defining symbols are used.

In this handbook the used integrated circuits are explained, but it is important to have a previous knowledge of some necessary details of its operation.

- 1.- Low state "0" It is defined when we have 0 volts
- 2.- High state "1" It is defined when there is supply voltage in a point. It will be 5V in the MPU and 10V in the Decoder.
- 3.- BUS It is used in the MPU module and defines a group of strips or cables which can be used by any of the modules connected to it.
- 4.- How the pins are numbered. Three practical examples of the numeration of pins 14, 16 and 24. (See fig.below)

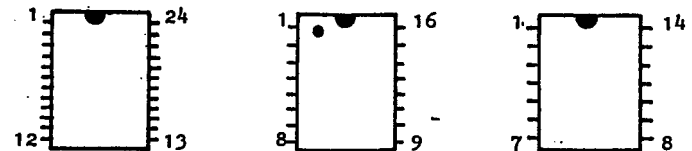

For representing the integrated circuits, two different methods are used. One consists in representing them with a symbol when they are simple circuits such as logical gates. In that case an integrated circuit can be composed of 2 to 4 gates. The other method consists in representing the integrated circuits (IC) with a rectangle. This method is used when the IC is complex.

Representation with symbols:

AND GATES - when a and b are 1; c will be 1

OR GATES - when a or b is 1; c will be 1

NAND GATES - when a and b are 1 then c will be 0  
If one of the inputs (a or b) is 0 then c will be 1

NOR GATES - when a and b are 0 then c will be 1  
If one of the inputs (a or b) is 1 then c will be 0  
(See fig. below)

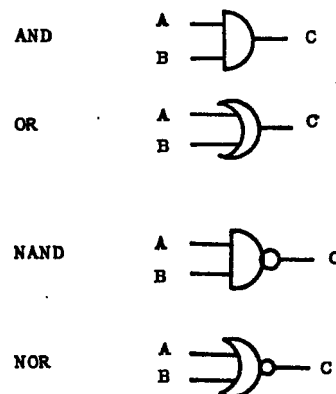

Representation with rectangles  
(See Fig. below)

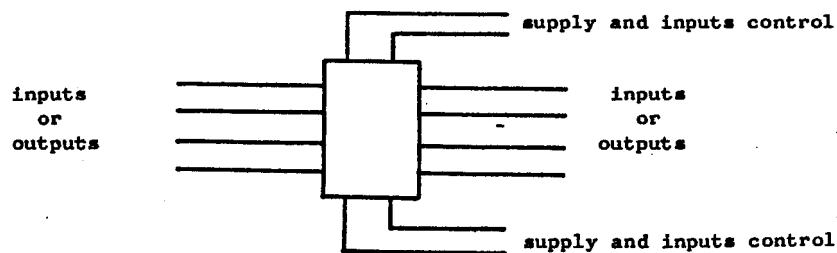

**NOTE:** After the troubleshooting methods of each module the function of the complex circuits is detailed.

### TRANSFORMERS

The primary of the main transformer is connected to the voltage through a fuse of 6A and has different inputs to be regulated according to the voltage line in each case.

The primary of the auxiliary transformer and the primary of the main transformer are joined in the 0-110V.

The secondaries of the main transformer are 0-7V, which are used to feed the lamp bulbs of the fixed lights. 0-28-30-33V, used to feed the electromagnet coils, whether in alternated current (direct from the transformer), in the case of the taca, ball dispenser, up-down targets, or through a rectifier bridge, which transforms the alternated current in continuous current, in the case of the flipper, bumpers and kickers. The secondary of the auxiliary transformer is 10-0-10V. Its use in the machine is to feed the different electronic modules and the different lamp bulbs used during the game.

Something to emphasize for the comprehension of the thyristor function, are the waveshapes, which are present in each one of the three points. (See fig.5).

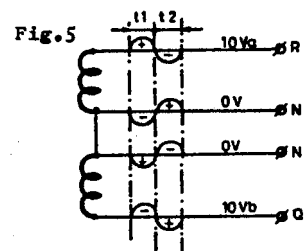

We will observe the waveshapes of a potential with regard to another. From 10Va to 0V and from 0V to 10Vb. When the 10Va point has the positive half wave, the 0V point has a negative half wave with regard to the 10Va potential; but positive with regard to the 10Vb potential, which at this moment has a negative half wave. (T1). Therefore, when the 10Va has the negative half wave, the 0V point has a positive half wave, with regard to the 10Va potential, but negative with regard to the 10Vb potential, which at the moment has a positive half wave. (T2).

RELAYS MODULE

<u>Sympton</u>	<u>Cause</u>	<u>Procedure</u>
A) None of the relays closed	a) Supply failure b) 10V line open c) 10V line shorted	Test with a voltmeter. The voltage at the connector between + and - has to be 10 VDC $\pm$ 1,5V. Localize the failure in decoder module Carry out a visual inspection looking for shorts. Once localized, replace fuses in decoder module.
B) Game relay does not close	a) It does not receive the command impulse b) Transistor open	With the test point on input Z and with the machine in game position, TL will be off. Localize failure in MPU module. With the test point on input Z and the machine ready for playing, TL will be on. Replace transistor.
C) Game relay is always open	a) Command impulse does not disappear b) Closed transistor	With the test point on input Z, TL will be always on. See failure in decoder module. With the machine in Game Over and test point on input Z, TL has to be off. Replace transistor.
D) The ball dispenser and target relays do not close.	a) Command impulse is not received. b) Open transistor	With the test point on input SC; TL will be off. See failure in module MPU. TL gets on at SC input at the moment of removing the ball. Replace transistor.

Sympton

	<u>Cause</u>	<u>Procedure</u>
E) The ball dispenser and target relays are always closed.	a) Command impulse does not disappear b) Closed transistor	With the test point on SC input, TL will be continuously on. See failure in MPU module. LT gets on at the moment of dispensing the ball when the test point is on SC input. Replace transistor.
F) The taca relays do not close	a) Command impulse is not received. b) Transistor open	With the test point on ZB input TL will be always off. See failure in decoder module. With the test point on ZB input. TL will get on when a credit by award is given, Replace transistor.
G) The taca relay is always closed.	a) Command impulse does not disappear b) Closed transistor.	With the test point on ZB input, TL will be always on. See failure in decoder module. With the test point on ZB input, TL will get on when a credit by award is given. Replace transistor.

COMPONENTS USED IN THE RELAYS MODULE

TRANSISTOR SC 148 C

PARTS OF THE MODULE

<u>d e s c r i p t i o n</u>	<u>q u a n t i t y</u>
Transistor SC 148 C	3
Relay 1T 280 ohms 15 A	3
Fuse 1K 1/4W 10%	3
Pin COMBOLINE	14
Printed circuits relays ref. 510068	1



CONE MODULE

<u>Sympton</u>	<u>Cause</u>	<u>Procedure</u>
A) None of the lights turns on	a) Supply failure b) 10V line open or shorted	Test with a voltmeter. The voltage at the connector between + and - has to be 10 VDC $\pm$ 1,5 V. Localize failure in decoder module. Carry out a visual inspection of shorts. Once localized, replace fuses in decoder module.
B) A stage never get lighted	c) Supply failure at common + of the cone chassis d) Defective 4028 integrated circuit.	Check if TL turns on when touching with the test point any of the 1,2,3,4,5,6 outputs of the board. If TL does not turn on, localize failure in decoder module. With TL, test input pulses at pins 10,13 and 14. If there are impulses, there must be impulses at output pins 14,2,15,1,6,7. If there are none, replace IC.
C) A stage is always on	a) Corresponding thyristor open b) No impulse activates the thyristor	With TL on output connector and on the corresponding pin, it will be always on. Replace thyristor. With TL on the integrated circuit output, TL has to be on. If not replace IC.
D) Stages 1,3 and 5 never get lighted.	a) Closed thyristor b) Command impulse does not disappear	With TL on the output connector and on the corresponding pin, it will be always off. Replace thyristor. With TL check if the impulse does not disappear on the integrated circuit pins 14,2,15,1,6,7. In that case replace integrated circuit.
E) Stages 2,3 and 6 never get lighted.	a) No command impulse at CO 1	Check with TL if the pulse reaches CO1. If it does not arrive, localize failure in decoder module.
F) Stages 4,5 and 6 never get lighted	a) No command impulse at CO 3.	Check with TL if the impulse reaches CO3, if it does not, localize failure in decoder module.
G) Stage 1 is always lighted and 5 and 3 occasionally. Never the rest.	a) Command impulse at CO1 does not disappear.	Check possible failure by carrying out a visual inspection for shorts. If there is no short, see failure in decoder module
H) Stage 2 is always lighted and 3 and 6 occasionally. Never the rest.	a) Command impulse in CO2 does not disappear.	Check possible failure by carrying out a visual inspection for shorts. If there is no short, see failure in decoder module.
I) Stage 4 is always lighted and 5 and 6 occasionally. Never the rest.	a) Command impulse in CO3 does not disappear	Check possible failure by carrying out a visual inspection for shorts. If there is no short, see failure in decoder module.
J) The cone light are not bright.	a) One of the diodes that makes the chassis positive is open.	See failure in decoder module.

Procedure

Check with TL if the impulse reaches CO2, if it does not, localize failure in decoder module.

Check with TL if the impulse reaches CO3, if it does not, localize failure in decoder module.  
Check possible failure by carrying out a visual inspection for shorts. If there is no short, see failure in decoder module

Check possible failure by carrying out a visual inspection for shorts. If there is no short, see failure in decoder module.

Check possible failure by carrying out a visual inspection for shorts. If there is no short, see failure in decoder module.

See failure in decoder module.



COMPONENTS USED IN THE CONE MODULE

THYRISTOR BT 106

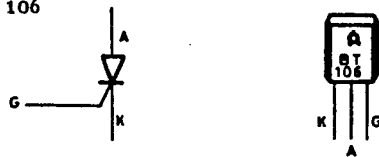

INTEGRATED CIRCUIT 4028

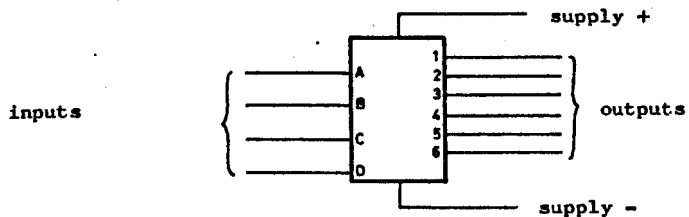

<u>Inputs</u>			<u>Outputs</u>					
A	B	C	1	2	3	4	5	6
0	0	0	0	0	0	0	0	0
1	0	0	1	0	0	0	0	0
0	1	0	0	1	0	0	0	0
1	1	0	0	0	1	0	0	0
0	0	1	0	0	0	1	0	0
1	0	1	0	0	0	0	1	0
0	1	1	0	0	0	0	0	1

PARTS OF THE MODULE

<u>Description</u>	<u>Quantity</u>
Thyristors BT 106 A	6
Fuses 1 K 1/4 W 10%	3
" 10 K 1/4 W 10%	6
Integrated circuit CD 4028 AE	1
Pin COMBOLINE	11
Printed circuit cone ref. 510064	1

THYRISTOR MODULE

<u>Sympton</u>	<u>Cause</u>	<u>Procedure</u>
A) None of the lights operates	a) Connector 10 fails	Test with a voltmeter if there is alternated voltage between the two pins of connector 10 and the potentials 10Va and 10Vb. The correct value is 10VAC. If the measured voltage is not correct, all the connectors between thyristor module and transformer should be checked.
B) The two lights corresponding to the same thyristor are always on.	b) 3Amp fuses are open	Carry out a visual inspection and check fuses. Then look for shorts in lamp sockets and bulbs. Replace fuses.
C) A group of panel lights never get lighted.	a) One of the diodes is closed. b) Respective thyristor remains open.	Disconnect the corresponding connector. Test with ohmmer which diode conducts in both senses. Replace that diode. With the test point check the anode of the thyristor (central pin). TL will be off, even with command impulse. Replace thyristor.
D) The two lights corresponding to the same thyristor do not turn on.	a) Defective 3 Amp fuse. b) No command impulse proceeding from MPU b) The thyristor remains open.	Carry out a visual inspection. Then look for shorts in lamp sockets and bulbs. Replace defective fuses. See failure in MPU module With the test point, check the anode of the thyristor. TL will be on even with the command impulse. Replace thyristor.

<u>Symptom</u>	<u>Cause</u>	<u>Procedure</u>
E) A light never turn on	a) Fused bulb b) Open diode	See filament and replace bulb. Disconnect the connector corresponding to the thyristor and diodes. With the ohmmer, check which diode conducts in both senses. Replace diode.

COMPONENTS USED IN THE THYRISTOR MODULE

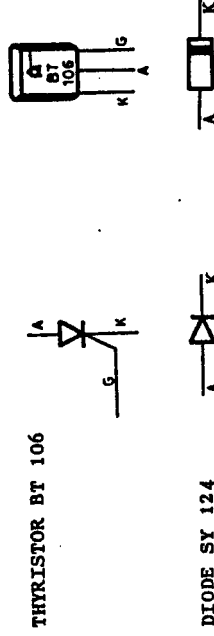

PARTS OF THE MODULE

<u>Description</u>	<u>Quantity</u>
Thyristors BT 106 A	23
Diodes SY 124	46
Fuses 10 K 1/4 W 10%	23
Pin COMBOLINE	72
Printed circuit thyristor ref. 510046	1

BELLS MODULE

<u>Symptom</u>	<u>Cause</u>	<u>Procedure</u>
A) The music is not heard	a) Supply failure b) Shorted or open 10V line c) Supply diode SY 124 is open d) There is no CA5 impulse e) The loudspeaker coil is cutted f) Output transistors closed.	Test with a voltmeter in the input connector The voltage has to be 10 VDC ± 1,5V. Localize failure in decoder module. Carry out a visual inspection for shorts. When the short is located, replace fuses in decoder module. With the test point on the ± of the input connector, TL has to be on. On the cathode of the diode TL will be off. Replace diode. With the test point on the + of the input connector and on the CA5 pin, TL has to be on when touching one of the playfield contacts. If it does not get on, see failure in decoder module. Check for continuity with the ohmmer the two terminals of the loudspeaker. If there is no continuity replace loudspeaker. With the test point on the cathode of the supply diode, TL will be off. Replace output transistor and, if necessary, fuses in decoder module.
B) At maximum volume the music is weakly heard	a) One of the output transistors is open	Put the test point on the emitter of one of the transistors. If TL turns on when there is no music transistor MC 150 is open. If TL is off while there is no music, transistor MC 140 is open.
C) Hum is heard in the loud speaker	a) Supply diode SY 124 is open.	Try with another diode connecting it in parallel with the diode in the module. If the hum disappears, replace the diode.

Sympton

Cause

Procedure

- b) Supply is superior to 10V.  
 a) Command impulse fails  
 D) One or some notes do not sound  
 E) Fading is not heard a) 4,7 uF capacitor is open,  
 See failure in decoder module  
 See if the command impulse arrives when touching a game contact, by testing with the test point on the pin of the input connector corresponding to the note which is not heard. If TL does not turn on, see failure in decoder module.  
 With the test point on the positive terminal of the capacitor TL has to turn on quickly when giving a command impulse at CA 5.

COMPONENTS USED IN THE BELL MODULE

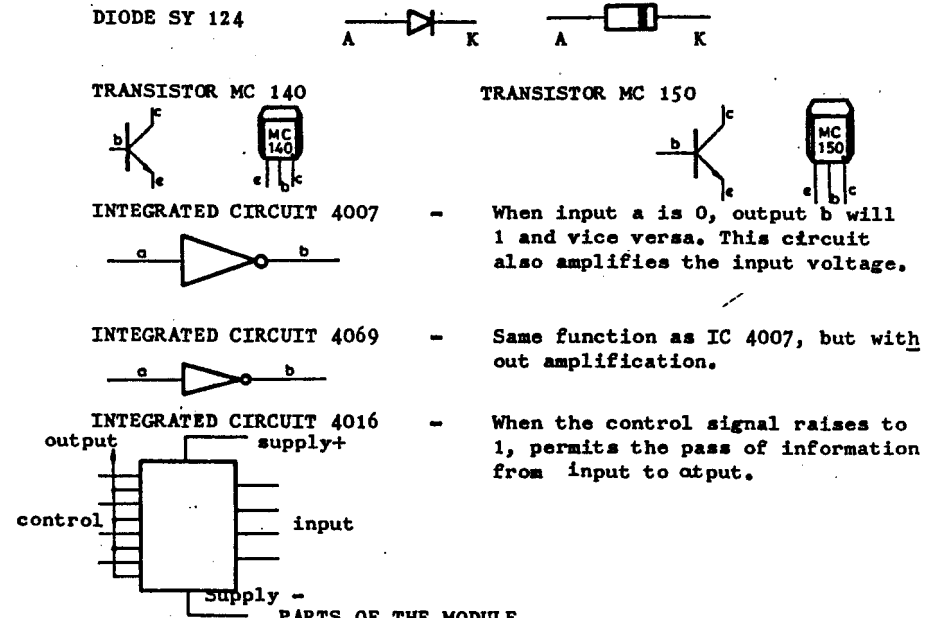

PARTS OF THE MODULE

description	quantity
Integrated circuit MC 14016BCP	1
" " CD 4069 BE	1
" " CD 4007 AE	1
Diode SY 124	1
Fuse 100 Ohms 1/4 W 10%	1
" 1 K 1/4 W 10%	5
" 100 K 1/4 W 10%	3
" 240 K 1/4 W 2%	1
" 330 K 1/4 W 2%	2
" 430 K 1/4 W 2%	1
" 560 K 1/4 W 2%	2
" 580 K 1/4 W 10%	1
" 1M 1/4 W 10%	2
" 10M 1/4 W 10%	2
Condenser styroflex 1 K 63 V 2%	1
" electrolytic 4,7uF 10V	1 (tantalum)
" " 100 uF 16V	1 (radial)
" " 1000 uF 16V	1 (radial or axial)
" MKM 0,1 uF 250V	1
Transistor MC 140	1
" MC 150	1
Potentiometer PT 15V 100 K with shaft	1
Pin COMBOLINE	9
Printed circuit bells ref.510067	1

## DISPLAYS MODULE

<u>Sympton</u>	<u>Cause</u>	<u>Procedure</u>
A) None of the numbers of the displays turns on	a) Supply failure b) Shorted or open 10V line c) Information superior to 9 in line L1 to L8	Test with the voltmeter the voltage at the input connector, which has to be 10 VDC $\pm$ 1,5V. Localize failure in decoder module. Carry out a visual inspection for shorts. When found replace fuses in decoder module. With the test point check in which line TL turns on. Verify with coding table and see which lines are connected to positive. Look for possible failure in decoder module.
B) A pair of numbers count even if it does not have to do so.	a) J control input is 0	Test with the test point that in input J, TL does not turn on. Look for failure in decoder module.
C) The unities hundreds and thousands do not count correctly.	a) One of the inputs L1, L2, L3, L4 is always 0 b) One of the inputs L1, L2, L3, L4 is always 1	With test point on L1, L2, L3, and L4, TL has to blink. If not turning on, look for shorts or failure in decoder module. With test point on L1, L2, L3 and L4, TL will be continuously on. Look for shorts of failure in decoder module.
D) The tenths, thousands and hundredthousands do not count correctly	a) One of the inputs L5, L6, L7, L8 is always 0 b) One of the inputs L5, L6, L7, L8 is always 1	With test point on L5, L6, L7 and L8, TL has to blink. If not turning on, look for shorts or failure in decoder module. With the test point on these inputs TL will be continuously on. Look for shorts or failure in decoder module.
E) A number of the display does not operate correctly.	a) Integrated circuit 4511 is damaged b) Damaged number	Setting the test program on input D of the IC, TL has to turn on. When testing the outputs, (a, b, c, d, e, f, g,) TL has to be on in any case. If not, replace integrated circuit. Proceed with the same test as in point a). In this case we will see that, when checking the outputs, TL will be always on. Replace in this case, the pair of numbers.
F) The display shows the score of a player different from the one, who is playing.	a) Command impulses not received at input J.	With the test point on the J input of the player whose score is wrong displayed, TL will be always off. Look for possible shorts or failure in decoder module.
G) A pair of numbers do not count correctly	a) Command input J does not become 0	Since 0 commands are very quick, it is impossible to test them with TL, or with a normal voltmeter. For checking we will make a bridge from J input to negative. If the pair counts, the displays board is correct. In that case look for failure in decoder module.

COMPONENTS USED IN THE DISPLAYS MODULES

INTEGRATED CIRCUIT 4511

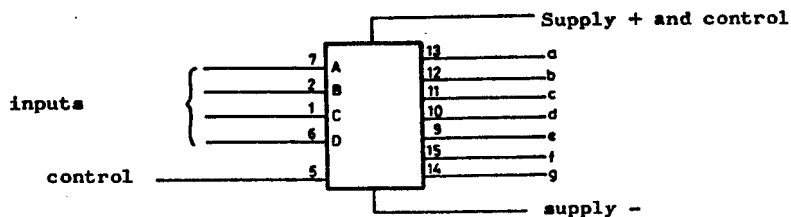

When the control signal becomes 1, the information in the output remains memorized. That means, if we change the inputs, the output will not change.

<u>CONTROL</u>	<u>INPUTS</u>				<u>OUTPUTS</u>						
	A	B	C	D	a	b	c	d	e	f	g
0	0	0	0	0	1	1	1	1	1	1	0
0	1	0	0	0	0	1	1	0	0	0	0
0	0	0	0	0	1	1	0	1	1	0	1
0	1	1	0	0	1	1	1	1	0	0	1
0	1	0	1	0	1	0	1	1	0	1	1
0	0	1	1	0	0	0	1	1	1	1	1
0	1	1	1	0	1	1	1	0	0	0	0
0	0	0	0	1	1	1	1	1	1	1	1
0	1	0	0	1	1	1	1	0	0	1	1

DISPLAY NSN 783

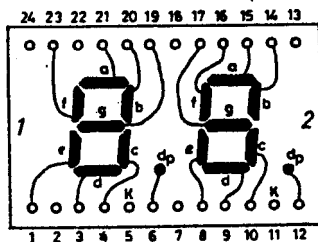

PARTS OF MODULE x 4 DISPLAYS

<u>Description</u>	<u>quantity</u>
Display NSN 783	9
Integrated circuit CD 4511 BE	18
Fuse 430 Ohms 1/4 W 10%	126
" 1 K 1/4 W 10%	41
" 1K2 1/4 W 10%	4
Condenser disc 10k	9
Pin COMBOLINE	49
Printed circuitdisplays ref. 510063	4
Plastic Plate with zeros IS 147	3
" " without zeros IS 148	1

<u>Description</u>	<u>Quantity</u>
Plastic divider MG-16	12
Lampsocket B-13	3
Screw 1/8x15 c/p F-156	12
Nut 1/8 AD-2	15
Terminal F-16	3

DECODER MODULE

<u>Symptom</u>	<u>Cause</u>	<u>Procedure</u>
A) Loudspeaker hum or supply voltage higher than 10 ± 5V	a) Closed TIP 33 transistor b) Closed MC 140 transistor c) Opened ZENER diode	When testing with a voltmeter emitter and collector have the same voltage and basic voltage is 10 VDC ± 1,5 V. Replace transistor. When testing with a voltmeter emitter and collector have the same voltage and the basic voltage is 11 VDC ± 1,5 V. Replace transistor. When testing with a voltmeter, the basic voltage and collector of MC 140 is the same. Replace ZENER diode.
B) There is no voltage supply	a) Open fuses	Check possible shorts in decoder, bells, cone, relays and displays modules. Replace fuses. If the fuses would blow again, remove the connectors of the decoder module and replace fuses. If the fuses blow, the failure is localized. If the fuses do not blow, connect one by one the connectors corresponding to bells, cone etc. checking in this way when the fuses are blowing and enabling to localize the defect module. For repair see the corresponding module.
	b) Transistor TIP 33 open.	Testing with the test point TL will be on in the collector and in the base of this transistor, but not in the emitter. Replace transistor.
	c) Transistor MC 140 open	Testing with the test point TL will turn on in the collector and in the base of this transistor but not in the emitter. Replace transistor.
	d) Zener diode closed	Testing with the test point, TL will not be on when touching the base of MC 140. Replace Zener diode.

<u>Symptom</u>	<u>Cause</u>	<u>Procedure</u>
C) Cone, bumper and players in game lights weakly illuminated	e) One of the diodes F31 closed. a) One of the fuses is open b) One of the F31 diodes is closed.	Remove the fuses and check with the ohm-meter for continuity in each of the diodes. Replace the shorted diode and put the fuses again. Carry out an inspection for shorts in lamp sockets bulbs, cone lights, bumper lights and players in game. Replace fuses. Remove the fuses and check if any of the diodes are not conducting in any sense. Replace non conducting diode.
D) Cone, bumper and players in game lights do not get on.	a) Open fuses b) One of the F31 diodes is closed.	Check possible shorts in lamp sockets, bulbs, cone lights, bumper lights and player in game lights. Check with the ohm-meter if the two F31 diodes are not closed. Replace the diodes, if necessary, put the fuses again and check. Remove the fuses and check with the ohm-meter for continuity in all diodes. Replace shorted diode and put the fuses again.
E) TL does not turn on when touching ± 10VDC	a) False contact of the female of the pin. b) Transistor SC 148 open c) LED diode open	Observe in the test cable if the female which has to enter the pin is very open or if the cable is cut because of the use. Fix it and check again. With the test point touching ± 10V, check with a voltmeter if the collector voltage is 12V and if the base voltage is 10V. Then, if the emitter voltage is 0V, replace transistor. Doing the same test as in point b), at the transistor emitter the voltage will be 11,5V and at the anode the voltage will be the same. Replace LED diode.

Symptom

Cause

Procedure

d) IN4148 diode open  
Testing with a voltmeter on the cathode, there will not be continuous voltage. Replace LED diode.

G) One player in game lights does not turn on

a) There is no command impulse.

With the test point on the corresponding IC output, check if TL does not turn on. Then check if the gate inputs are correct or if there is a short to negative. Repair short or replace IC. Check again.

b) Open thyristor

With the test point on the IC output, TL will turn on and also will turn on in the anode of the thyristor. Replace thyristor.

H) A pair of numbers of the display do not count correctly

a) J output does not reach 0.

Once checked that the displays board is correct, check if there is any short to positive from the IC outputs in decoder module. If the rest of the displays operate correctly, replace IC.

I) A pair of numbers of the display are always counting.

a) J input has always 0 volts.

Test if TL does not turn on when touching the IC output. Look for possible shorts from this output to negative. If there is no short and the rest of the displays operate correctly, replace IC.

J) The display of the 4 players do not operate correctly.

a) One of the D1, D2, D3, D4 input is defective.

Check which pair of numbers do not operate correctly and to which player they belong. Compare this information with the decodification table of the 74C42 IC and see which is the defective line. Carry out a visual inspection for possible shorts. If there is none, test with a voltmeter on the common inputs that go to -, if the voltage is 2,7VDC  $\pm$  0,5V. If the voltage is not correct, check the voltage divider (resistors of 22 and 10K). If it is correct test the D inputs. In order to check this, make a bridge from the input connector to negative and with a voltmeter test if the voltage at the IC output is 0. Then make a bridge to the 5 positive of the MPU and test if the output is 1.

Symptom

Cause

Procedure

If these proofs are correct, the defect has to be localized in the MPU. If they are not correct, replace LM 324 IC.

K) The 4 players counters and the player lights bells, cone ball dispenser and Taca do not operate correctly.

a) Defective D1 input.

Same procedure as in symptom J.

L) The unities, hundreds and tenths thousands do not operate correctly and sometimes turn off.

a) One of the lines L1, L2, L3, L4 is positive shorted.

With the test point, check at which line TL is always on. Look for possible shorts. If there are no shorts, check if on the corresponding N input, TL is always on. If it is always on, see failure in MPU. If TL blinks, or is always on, IC LM 324 is defective. Replace and check it again.

M) The unities, hundreds and tenths thousands do not operate correctly.

a) One of lines L1, L2, L3, L4 is negative shorted.

With the test point, check at which line TL is always off. Look for possible shorts. If there are no shorts, check if on the corresponding N input TL always is off. If this happens see failure in MPU. If TL blinks, IC LM 324 is defective. Replace and check again.

N) The tenths, thousands and hundredthousands do not operate correctly and sometimes turn off.

a) One of lines L5, L6, L7, L8 is Positive shorted.

Same procedure as for symptom L.

O) The tenths, thousands and hundredthousands do not operate correctly.

a) One of lines L5, L6, L7, L8 is negative shorted.

Same procedure as for symptom M

<u>Sympton</u>	<u>Cause</u>	<u>Procedure</u>
P) The Taca relay does not operate correctly.		
1/ Never closes	a) There is no command im-pulse at command output	With the test point on the IC 74C175 output, TL will not light when Taca has to operate. Look for shorts. If there are no shorts, check on input N8 if TL blinks and turns on when Taca turns on. If the TL does not blink see failure in MPU.
2/ Is always closed	a) Command output positive shorted.	With the test point on the IC 74C175 pin, TL will be always on. Look for shorts. If there are no shorts, check on the N8 input if TL blinks. If this happens, replace IC 74C175. If not, see failure in MPU.
Q) The ball dispenser and targets relays do not operate correctly.		
1/ Never closes	a) There is no pulse at command output.	Same procedure as for sympton P1.
2/ Is always closed	a) Command output positive, shorted.	Same procedure as for sympton P2.
R) Bells do not sound, failure in some notes and fading.	a) Command signal never becomes positive. b) The command signal of the note never becomes positive.	Look for possible shorts. With the test point on CA5 output connector and touching any contact, TL should turn on. Check if on input N5, TL blinks and turn on when touching the contact. If it turns on replace IC 74C175. If it does not turn on, see failure in MPU.  Look for possible shorts. With the test point on the output connector and touching the contact corresponding to the note to sound, TL has to be on. See in the corresponding input if TL blinks and turns on when touching the contact. If TL turns on, replace IC 74C175. If not see failure in MPU.

<u>Sympton</u>	<u>Cause</u>	<u>Procedure</u>
S) Bumpers light never turn on.	a) Bulbs blown b) There is no command signal. c) Open thyristor	With test point on LB, TL will not light. Replace bulbs.  With the test point on the corresponding IC pin, check if TL turns on. If it does not turn on, check on pin N4 if TL blinks. If TL blinks replace IC 74C175 and check again. If it does not blink, see failure in MPU.  When the command signal is in the IC pin and with the test point on the thyristor anode, TL turns on. Replace thyristor.
T) The cone lights do not turn on.	a) In C01, C02 and C03 there is no command signal.	With the test point on the output connector, check if TL turns on when the cone has to operate. If it does not turn on check if on inputs N1, N2, N3, TL blinks. If TL blinks replace IC 74C175. If not see failure in MPU.
U) Cone lights do not operate correctly.		
1/ Some stages turn on and some do not.	a) Defective command signals or negative shorted.	Look for possible shorts. If there are no shorts, put test program and with the test point on the output connector, check if TL blinks on C01, C02, C03. If one of the command signals does not turn on, check corresponding N input. If TL blinks, replace IC. If TL does not blink, see failure in MPU.
2/ Some stages are always on.	a) Defective command signal or positive shorted.	Look for possible shorts. If there are none, with the test point check on which signal is continuously on. Check the corresponding N input, if at the input TL blinks, replace IC 74C175. If TL is continuously on, see failure in MPU.



**COMPONENTS USED IN THE DECODER MODULE**

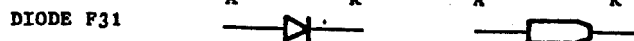
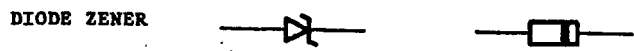
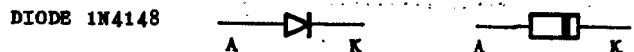

TRANSISTOR MC 140 (See components in bells module)

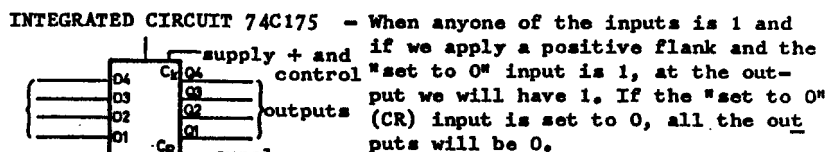
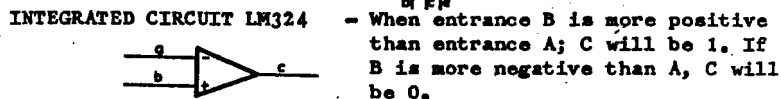
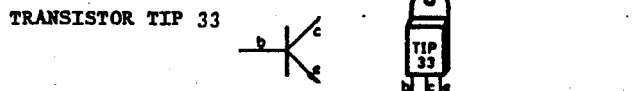

THYRISTOR ( " " in cone module)



inputs

CR	CK	D1, D2, D3, D4.	Q1, Q2, Q3, Q4.
1		1	1
1		0	0
0	anything	anything	0

**INTEGRATED CIRCUIT 74C42**

- Output 0. (  ) Positive flank impulse to control cone, ball dispenser, taca and bumper lights.
- Output 1. (  ) Positive flank impulse to control bells and players in game.
- Output 2. Controls, when becomes 0 the pair 100.000, 10.000 of the first player.
- Output 3. When becomes 0, permits the pair 10.000, 100 of the first player to count.
- Output 4. When becomes 0, permits to count the pair 10, 1 of the first player.
- Output 5. Same as output 2, but with the second player.
- Output 6. Same as output 3, but with the second player.
- Output 7. Same as output 2, but with the third player.
- Output 8. Same as output 3, but with the third player.
- Output 9. Same as output 2, but with the fourth player.

inputs				outputs									
A	B	C	D	0	1	2	3	4	5	6	7	8	9
0	0	0	0	0	1	1	1	1	1	1	1	1	1
1	0	0	0	1	0	1	1	1	1	1	1	1	1
0	1	0	0	1	1	0	1	1	1	1	1	1	1
1	1	0	0	1	1	1	0	1	1	1	1	1	1
0	0	1	0	1	1	1	1	0	1	1	1	1	1
1	0	1	0	1	1	1	1	1	0	1	1	1	1
0	1	1	0	1	1	1	1	1	1	0	1	1	1
1	1	1	0	1	1	1	1	1	1	1	0	1	1
0	0	0	1	1	1	1	1	1	1	1	0	1	1
1	0	0	1	1	1	1	1	1	1	1	1	1	0

**PARTS OF THE DECODER MODULE**



description	Quantity
Integrated circuit MM74C72	1
" " MM74C175	1
" " CD4001AE	1
" " CD4023AE	1
" " LM324 (only for E-PROM)	3
Thyristor BT106A	5
Transistor MC140	1
Transistor TIP33	1
Transistor SC148C	1
Diode F31	4
Diode Zener 11V	1
Diode 1N4148	3
Diode LT	1
Fuses M 3A	4
Fuse-holder	8
Printed circuit decoder ref.51066	1
Rivets printed circuit	104
Pin Comboline	87
Divider 6 mm	4
Fuse 2,7 ohms 2W 10%	1
" 5,6 " 1W 10%	4
" 220 " 1/4W 10%	2
" 1K " 1/4W 10%	25
" 2K2 " 1/4W 10%	2
" 10K " 1/4W 10% (only E-PROM)	1
" 10K " 1/4W 10%	22
" 22K " 1/4W 10% (only E-PROM)	1
" 100K " 1/4W 10%	1
" 220K " 1/4W 10% (only E-PROM)	12
Condenser MKM 0,1 uF 250V (only E-PROM)	1
" disc 10K	2
" tantalum 4,7 uF 16V	1
" electrolytic 10uF 16V radial	1
" " 47uF 16V "	1
" " 100uF 10V radial or axial	1
" " 1000uF 12V radial or axial	1

<u>d e s c r i p t i o n</u>	<u>q u a n t i t y</u>
Condenser electrolytic 5000uF 16V axial	1
Radiator small thyristor	1
" big	1
Screws 1/8 x 5	5
Nuts 1/8 AD-2	5

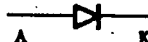

CREDIT AND MATCH FEATURE MODULE

<u>Sympton</u>	<u>Cause</u>	<u>Procedure</u>
A) The 00 of the match feature or the 1 of the credits do not turn on	a) Blown bulbs b) There is no command impulse c) Open transistor	Checking with the test point on the collector of transistor 2N3794, TL has to turn on. If it does not turn on replace bulb. Checking with the test point on the transistor base TL has to turn on. If it does not turn on, see failure in MPU. Checking with the test point, there will be a command impulse at the base and TL will be lighted. In the collector TL will be lighted too. Replace transistor.
B) The 00 of the match feature or the 1 of credits is always on.	a) Closed transistor	Checking with the test point and with the machine on play, TL will not turn on at the base and neither at the collector. Replace transistor.
C) The LED, which shows the credits and the match feature never turn on.	a) If the LED is the match feature one, switch the ball in extra ball position b) Open transistor c) There is no command impulse	Check in the MPU module that the switch is not in Extra Ball position. Test with a voltmeter the base of transistor (before the resistor). The voltage will be 2VDC, at the collector we will have 5VDC. Replace transistor. Testing with a voltmeter the transistor base (before the resistor), the voltage will be 2VDC. If the voltage is different, see failure in MPU.

COMPONENTS USED IN THE DECODER MODULE



DIODE 1N4148  

DIODE ZENER  

DIODE F31  

TRANSISTOR MC 140 (See components in bells module)

THYRISTOR ( " " in cone module)

TRANSISTOR TIP 33  

INTEGRATED CIRCUIT LM324 - When entrance B is more positive than entrance A; C will be 1. If B is more negative than A, C will be 0.



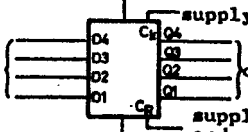

INTEGRATED CIRCUIT 74C175 - When anyone of the inputs is 1 and if we apply a positive flank and the control "set to 0" input is 1, at the output we will have 1. If the "set to 0" (CR) input is set to 0, all the outputs will be 0.



CR	CK	D1. D2. D3. D4.	Q1. Q2. Q3. Q4.
1		1	1
1		0	0
0	anything	anything	0

INTEGRATED CIRCUIT 74C42

- Output 0. (  ) Positive flank impulse to control cone, ball dispenser, taca and bumper lights.
- Output 1. (  ) Positive flank impulse to control bells and players in game.
- Output 2. Controls, when becomes 0 the pair 100.000, 10.000 of the first player.
- Output 3. When becomes 0, permits the pair 10.000, 100 of the first player to count.
- Output 4. When becomes 0, permits to count the pair 10, 1 of the first player.
- Output 5. Same as output 2, but with the second player.
- Output 6. Same as output 3, but with the second player.
- Output 7. Same as output 2, but with the third player.
- Output 8. Same as output 3, but with the third player.
- Output 9. Same as output 2, but with the fourth player.

inputs				outputs									
A	B	C	D	0	1	2	3	4	5	6	7	8	9
0	0	0	0	0	1	1	1	1	1	1	1	1	1
1	0	0	0	1	0	1	1	1	1	1	1	1	1
0	1	0	0	1	1	0	1	1	1	1	1	1	1
1	1	0	0	1	1	1	0	1	1	1	1	1	1
0	0	1	0	1	1	1	1	0	1	1	1	1	1
1	0	1	0	1	1	1	1	1	0	1	1	1	1
0	1	1	0	1	1	1	1	1	1	0	1	1	1
1	1	1	0	1	1	1	1	1	1	1	0	1	1
0	0	0	1	1	1	1	1	1	1	1	1	0	1
1	0	0	1	1	1	1	1	1	1	1	1	1	0

PARTS OF THE DECODER MODULE

description	Quantity
Integrated circuit MM74C72	1
" " MM74C175	1
" " CD4001AE	1
" " CD4023AE	1
" " LM324 (only for E-PROM)	3
Thyristor BT106A	5
Transistor MC140	1
Transistor TIP33	1
Transistor SC148C	1
Diode F31	4
Diode Zener 11V	1
Diode 1N4148	3
Diode LT	1
Fuses M 3A	4
Fuse-holder	8
Printed circuit decoder ref.51066	1
Rivets printed circuit	104
Pin Comboline	87
Divider 6 mm	4
Fuse 2,7 ohms 2W 10%	1
" 5,6 " 1W 10%	4
" 220 " 1/4W 10%	2
" 1K " 1/4W 10%	25
" 2K2 " 1/4W 10%	2
" 10K " 1/4W 10% (only E-PROM)	1
" 10K " 1/4W 10%	22
" 22K " 1/4W 10% (only E-PROM)	1
" 100K " 1/4W 10%	1
" 220K " 1/4W 10% (only E-PROM)	12
Condenser MKM 0,1 uF 250V (only E-PROM)	1
" disc 10K	2
" tantalum 4,7 uF 16V	1
" electrolytic 10uF 16V radial	1
" " 47uF 16V "	1
" " 100uF 10V radial or axial	1
" " 1000uF 12V radial or axial	1

<u>d e s c r i p t i o n</u>	<u>q u a n t i t y</u>
Condenser electrolytic 5000uF 16V axial	1
Radiator small thyristor	1
" big	1
Screws 1/8 x 5	5
Nuts 1/8 AD-2	5

CREDIT AND MATCH FEATURE MODULE

<u>Symptom</u>	<u>Cause</u>	<u>Procedure</u>
A) The 00 of the match feature or the 1 of the credits do not turn on	a) Blown bulbs b) There is no command impulse c) Open transistor	Checking with the test point on the collector of transistor 2N3794, TL has to turn on. If it does not turn on replace bulb. Checking with the test point on the transistor base TL has to turn on. If it does not turn on, see failure in MPU. Checking with the test point, there will be a command impulse at the base and TL will be lighted. In the collector TL will be lighted too. Replace transistor.
B) The 00 of the match feature or the 1 of credits is always on.	a) Closed transistor	Checking with the test point and with the machine on play, TL will not turn on at the base and neither at the collector. Replace transistor.
C) The LED, which shows the credits and the match feature never turn on.	a) If the LED is the match feature one, switch the ball in extra ball position b) Open transistor c) There is no command impulse	Check in the MPU module that the switch is not in Extra Ball position. Test with a voltmeter the base of transistor (before the resistor). The voltage will be 2VDC, at the collector we will have 5VDC. Replace transistor. Testing with a voltmeter the transistor base (before the resistor), the voltage will be 2VDC. If the voltage is different, see failure in MPU.

Symptom

- D) The LEDs that show the credits and the match feature are always on and show the same number.
- E) One of the LEDs does not count correctly and appear strange numbers.

Cause

- a) Closed match feature LED transistor
- a) Defective LED.
- b) The command impulse does not arrive.

Procedure

Checking with a voltmeter at the base of the transistor (before the resistor), there will be 2VDC. If there is a different voltage, see failure in MPU. If not replace transistor.

Localize which is the segment that fails. Check if on the corresponding module input TL turns on. If this happens, replace LED.

If at the module input, TL does not turn on, see failure in MPU module.

COMPONENTS USED IN THE CREDIT AND MATCH FEATURE

TRANSISTOR 2N3794

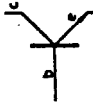

CREDIT AND MATCH FEATURE COUNTER LED MAN 74 A

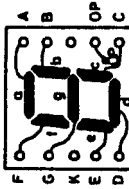

PARTS OF THE MODULE

<u>description</u>	<u>quantity</u>
LED MAN 74 A	2
Lamps 12 V miniature	3
Fuse 1K 1/4W 10%	3
" 4K7 1/4W 10% RCA	2
Transistor 2N3794 SA 3444/123A	5
Condenser FACO MOA 0,22 uF 100V	1
Printed circuit ref. 510050	1
Plastic plate credit and match feature	
IS-149	1
Plastic divider MG-16	4
Screws 1/8 x 15 c/p F-156	4
Nut 1/8 AD-2	4

MPU MODULE

<u>Sympton</u>	<u>Cause</u>	<u>Procedure</u>
A) Test program of MPU does not operate, neither the game lights turn on at the playfield.	a) Open fuses because of closed Zener diode. The Zener diode is closed because more than 10V has been applied at the input. b) +5V supply open or shorted 1/ Open transistor MC150 2/ Open transistor SC148 3/ Closed Zener diode.	Remove fuses and check them. If they are open disconnect one of the pins of the Zener diode and with the ohmmer check if there is continuity in both senses. If it conducts in both senses, replace diodes and fuses. Check again.  Checking with the test point on emitter and base, TL will be on. Checking on collector, TL will be off. Replace MC150.  Checking with the test point on the base, TL will be lighted. On the emitter and base, it will not light. Replace SC148.  TL will turn on when checking the emitter of transistor MC150 and will be off when checking the base of SC148. Replace Zener diode.
1. The test program stops at a number. 1/ Stops at 0.	a) Supply failure  b) Address or data buses shorted or open.	With a voltmeter check if the voltage of +5VDC, +12VDC, -5VDC on the pins of the E-PROM are correct. In the series machines, it is only necessary to have +10VDC at pin 24. If anyone of the voltages is not correct, check the voltage at the terminals of the components and replace them if defective.  Check with the ohmmer on the pins of the CPU if there is any line shorted to another to negative or to positive. That means: For checking the data bus put a plug of the ohmmer on pin 15 (B0) and check for continuity with the rest of the pins 8,9,10,11,12,13,14, with + and -.

Sympton

<u>Cause</u>	<u>Procedure</u>
c) Reset circuit or synchronization with the voltage line.	If in any of these measures the ohmmer shows 0 Ohms there is continuity because of a short; localize the short and repair. If the ohmmer shows a resistance but does not arrive at 0, everything is correct. The same steps are to be taken with the address bus (pins 25 to 32 of the CPU). In this way we will see that there are no shorted buses. When checking for open circuits, with the ohmmer and MPU schedule, we must follow the trace, looking for possible shorts. Afterwards check the whole trace for continuity.  The reset circuit actuates over pin 3 of the CPU. If we touch with the test point this pin and TL turns on, this is correct, then follow the trace and with TL see informations at the distinct control gates of this signal. A possible cause is, that transistor SC158 is closed. This can be checked easily because TL will not be on at the emitter. Replace transistor and check again.  The synchronization circuit is composed by the gates of the circuit 23, pins 8,9,10 and 12,13,11. With the voltmeter check if on pins 10 and 11, 2 VDC is given. If this happens, everything is correct. If one of the pins does not have this voltage, then try to localize the failure in the integrated circuit, resistors or capacitors.
a) The CPU circuit does not remain connected to ROM A	Look for possible shorts between bus lines, to positive or to negative, as made for sympton Bib. Also check if there are open lines. If the above is correct, then check with the ohmmer the connections of the circuit 4042 (24) for any shorts or open lines.
2/It stops at 1.	
a) The CPU circuit does not remain connected to ROM B.	Look for possible shorts between the bus lines, to positive or to negative as made for sympton Bib. Also check if there are open lines. If the above is correct, then
3/ It stops at 2.	

Sympton

Cause

Procedure

check with the ohmmeter the connections of the circuit 4042 (24) for any short or open line.

- |   |  |  |
|---|--|--|
| 4/ It stops at 3.   | a) The CPU does not remain connected to RAM A.         | Same procedure as for last symptom.  |
| 5/ It stops at 4.   | a) The CPU does not remain connected to RAM B.         | Same procedure as for last symptom   |
| 6/ It stops at 5.   | a) The CPU does not remain connected to the input.     | Check with the voltmeter if there is no open line between the CPU circuit and circuits 4016 (21 and 22). If the above is correct, check for continuity in the distinct outputs C1,C2,C3,C4 C5 of circuit 4028 (20). Check also if transistor SC148 placed at the second column, is not open.   |
| 7/ It stops at 6.   | a) The pin 36 of the CPU does not receive signals      | Check with the ohmmeter if the trace between pin 36 of CPU and pin 4 of circuit 19 is correct. If this is correct, connect the machine to the voltage line and check the voltage on pin 4 of circuit 19, which has to be 5VDC. If the voltage is different, check voltages at the input. They have to be 2VDC. If this voltage is not correct, verify resistor and capacitor.<br>Check if the contact does not remain closed because of a incorrect regulation. Regulate it and check again. |
| C) A contact of the machine does not add points or does not do anything when touched. | a) It is always closed.<br>b) Failure at input to MPU. | When checking with the test point at one of the contact plates, TL has to blink weakly. Then close contact and check if the signal passes to the other plate and follow the cable up to the MPU; At the same time follow the impulse over the scheme in order to know where it disappear. With this test we can localize the component, which does not allow the pass of the signal.   |

Sympton

Cause

Procedure

- |  |  |   |
|--|--|---|
| D) One or some of the game lights do not turn on and the credit and match feature counters do not operate correctly. | a) Defective issue of the command impulse from the MPU.          | Localize, with the help of the letter code foreseen in each module, the defect integrated circuit. Check with the ohmmeter if the input and output connections of the gates are correct, that is to say, there is no open or shorted circuit. Check also if there is continuity between MPU output and the input of the auxiliary module to verify the good contact of the connector. |
| E) At the decoder module the input D or N are not correct.   | a) Defective MPU command output.                                 | The same procedure as for symptom D.  |
| F) The coin micros do not count the correct credits.   | a) Dirty credit regulation switches.                             | Clean with a spray the switches and let them rotate a few times. Check again.   |
| G) When disconnecting the machine, it does not store the information in credit counters and players displays.        | a) RAM B has no supply   | With a voltmeter check the voltage at pin 18 of RAM B (33). When the machine is connected this voltage has to be 5VDC $\pm$ 0,5V. When the machine is disconnected this voltage has to remain at the same value. If this voltage falls down to zero, we have diode 1N4148 closed. Replace diode and check again.  |
| H) Some game lights, the match feature or credit LEDs blink.   | a) One of the transformer windings is badly soldered or shorted. | Check if the outputs 10Va, 0v and 100Vb of the transformer are well soldered and there are no shorts between the terminals.   |

IF WITH ALL THE ABOVE CHECKING IT WOULD NOT BE POSSIBLE TO FIND THE FAILURE AND REPAIR IT, IT WILL BE NECESSARY THAT YOU REVERT TO OUR LABORATORY WHERE SPECIALIZED STAFF AND MODERN EQUIPMENT WILL PROCEED WITH THE IMMEDIATE REPAIR. THEREFORE THE DEFECT MODULE SHOULD BE SENT TO US.

COMPONENTS USED IN THE MPU MODULE

DIODE SY 124 (See components in thyristor module)

DIODE 1N4148 (See components in decoder module)

ZENER DIODE (See components in decoder module)

TRANSISTOR SC 148 (See components in relays module)

TRANSISTOR SC 158



INTEGRATED CIRCUIT 4019 (11 and 12)

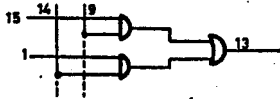

Four squares form one integrated circuit. One square is formed by:

INTEGRATED CIRCUIT 4511 (See components displays module) (13)

INTEGRATED CIRCUIT 4042 (14, 17 and 24)

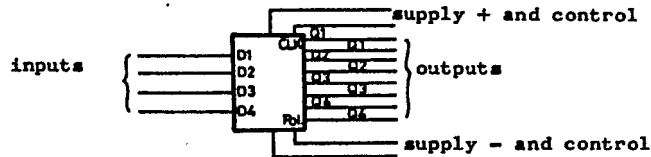

CLK	Pol.	O1.	O2.	O3.	O4.
0	0	D1	D2	D3	D4
	0	Memorized			
1	1	D1	D2	D3	D4
	1	Memorized			

INTEGRATED CIRCUIT 4013 (15)

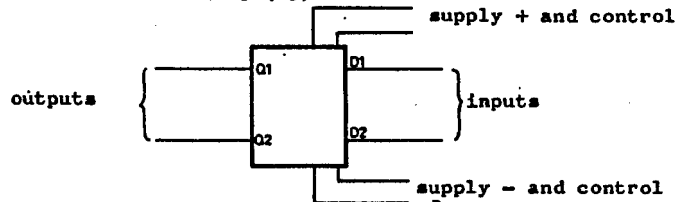

CLK	D1.	D2.	O1.	O2.
0	0	0	0	0
1	1	1	1	1

INTEGRATED CIRCUIT 4028 (20)

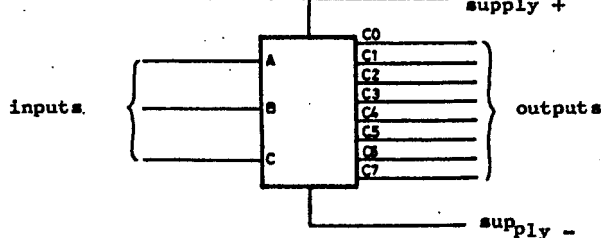

inputs

A	B	C
0	0	0
1	0	0
0	1	0
1	1	0
0	0	1
1	0	1
0	1	1
1	1	1

outputs

C0	C1	C2	C3	C4	C5	C6	C7
1	0	0	0	0	0	0	0
0	1	0	0	0	0	0	0
0	0	1	0	0	0	0	0
0	0	0	1	0	0	0	0
0	0	0	0	1	0	0	0
0	0	0	0	0	1	0	0
0	0	0	0	0	0	1	0
0	0	0	0	0	0	0	1

INTEGRATED CIRCUIT 4016 (21 and 22) (See components bells module)

INTEGRATED CIRCUIT 4069 (25) (See components bells module)

INTEGRATED CIRCUIT ROM A and B 1834 D (26 and 30)

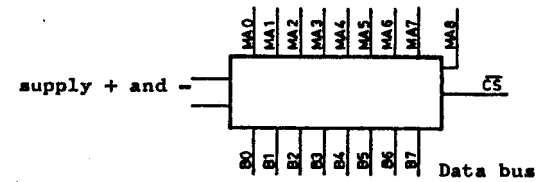

When the control signal CS falls to 0, through the 8 lines of data bus will be given the information corresponding to the address which at the moment is in the address bus.

INTEGRATED CIRCUIT RAM A and B 1824 D (27 and 33)

When the control signal CS gets negative, there are two possibilities:

$\overline{MWR}=0$  and  $\overline{MRD}=1$  - In this case the information which is in the data bus will be written in the RAM circuit at the address indicated by the address bus.

$\overline{MWR}=1$  and  $\overline{MRD}=0$  - In this case the information in the address shown by the address bus, will be leaving through the data bus.



INTEGRATED CIRCUIT CPU 1802 D (28) - Controls the rest of the circuits of the machine. Its function is quite complex.

When the input CLEAR becomes 0; the CPU is set to 0. When giving 1 again, the address bus starts to count. It starts with 000.000, then 000.001 and so on.

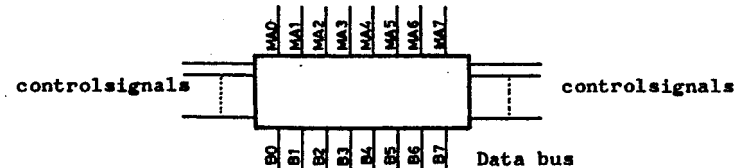



PARTS OF THE MODULE MPU

<u>d e s c r i p t i o n</u>	<u>q u a n t i t y</u>
Integrated circuit CD4013AE	1
" " CD4001AE	1
" " CD4011AE	3
" " MC4016CP	2
" " CD4019AE	2
" " CD4023AE	1
" " CD4028AE	1
" " CD4042AE	3
" " CD4069BE	1
" " CD4072BE	1
" " CD4075BE	2
" " CD4081BE	8
" " CD4511BE	1
" " CPU CDP 1802 D	1
" " RAM CDP 1824 D	2
" " ROM CDP 1834 D	2 (only for ROM)
" " E-PROM 2708	2 (only for E-PROM)
Transistor SC158	1
" MC150	1 (only for E-PROM)
" MC140	1 (only for E-PROM)
" MC140	1
" SC148	1
Diode SY124	6 (only for E-PROM)
" SY124	4 (only for ROM)
" 1N148	5
" ZENER 5,6V	2 (only for E-PROM)
" " 11V 400mW	1 (only ROM)
" " 12V 400mW	1 (only for E-PROM)
" " 15V 400mW	1
Sliding switch 2x1	2
Fuse-holder	4
Fuse 1 A	2
Pin Comboline	86
Rivets printed circuit	370
Metal plate MPU	1
Printed circuit auxiliar MPU	4 (only for E-PROM)
Switch button	2
Rotative switch 8x1	2
Printed circuit MPU ref.510049	1
Socle 40 pins	1
" 24 pins	1
Radiator	1
Dividers 10mm	9
Screw 1/8 x 5	9
Nut 1/8 AD-2	9
Resistance 47 1W	1 (only for E-PROM)
" 100 1/4W 10%	1
" 150 1/4W 10%	7 (Only for E-PROM)
" 390 1/4W 10%	7 (Only for ROM)
" 470 1/4W 10%	1 (Only for E-PROM)
" 470 1/4W 10%	1
" 1K 1/4W 10%	14

<u>d e s c r i p t i o n</u>	<u>q u a n t i t y</u>
Resistance 4K7W1/4 10%	4
" 10K 1/4W 10%	89
" 100K 1/4W 10%	22
" 470K 1/4W 10%	2
" 1M 1/4W 10%	1
Condenser 82 pF ceramic	1
" 1K "	8
" 10K "	5
" MKM 0,01 uF 250V	2
" MKM 0,22 uF 100V	1
" MKM 0,47 uF 100V	1
" electrolytic 220 uF 16V radial	3 (Only for E-PROM)
" " 220 uF 16V "	1 (only for ROM)
" " 1000 uF 16V "	1 (Only for E-PROM)
" " 2200 uF 16V axial	2 (Only for ROM)
" " 4700 uF 16V "	2 (Only for E-PROM)
Plastic plate game selector	1
" " balls-game 3-5 balls	1

CODE OF THE MODULES

In all modules, close to the pins, there is a printed code number.

The same code number is used to indicate the output pin of a module and the one corresponding to the input of another module. Each codification defines a specific function and therefore there are not two different functions with the same code number, except the two cases as detailed below:

1.- Relation between input code of the thyristor module and the corresponding outputs of MPU module.

<u>CODE THYRISTOR</u>	<u>CODE MPU</u>
T1	W7
T2	U7
T3	U6
T4	U5
T5	U4
T6	U3
T7	U2
T8	U1
T9	V8
T10	V7
T11	V6
T12	V5
T13	V4
T14	V3
T15	V2
T16	V1
T17	—
T18	W4
T19	W3
T20	W2
T21	W1
T22	W8
T23	W6
T24	W5

2.- Relation between input code of Displays modules and corresponding outputs of Decoder module.  
See in code diagram the indication corresponding to the pins of the connectos numbers 8-7-6 and 5 of the Decoder module with the ones corresponding to the Displays.

PLAYMATIC

PIN-BALL MACHINE  
**THYRISTORS**  
CONTROL BOARD SCHEMATIC

D-BUJALDO  
COMPROBADO

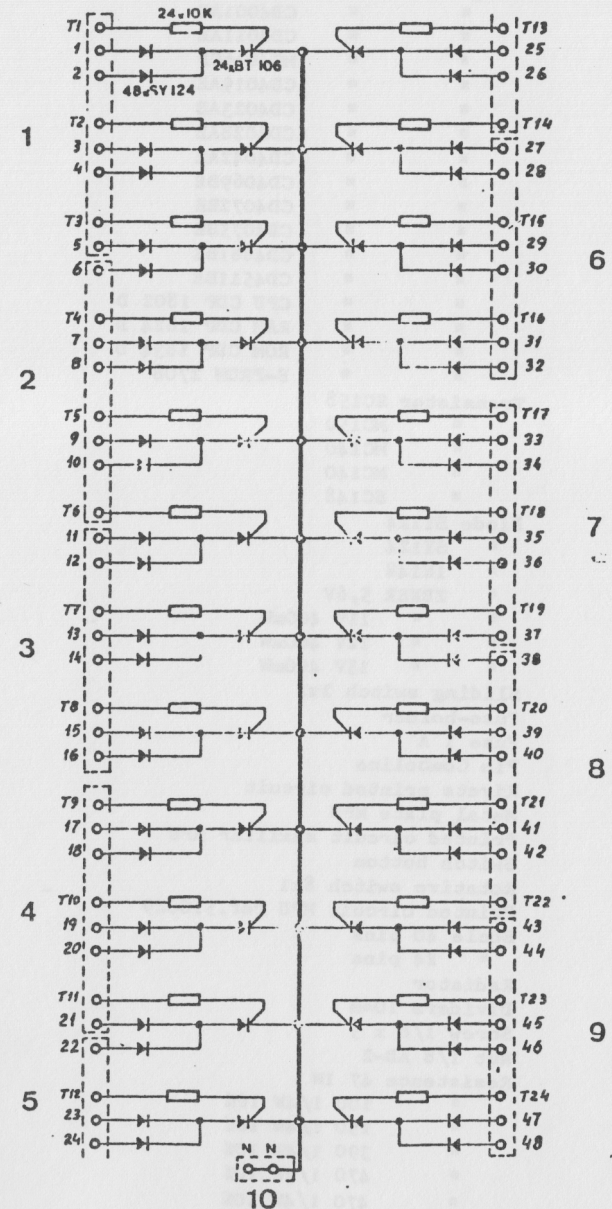

PLAYMATIC

PIN-BALL MACHINE  
SOUND  
CONTROL BOARD SCHEMATIC

DIBUJADO   
COMPROBADO

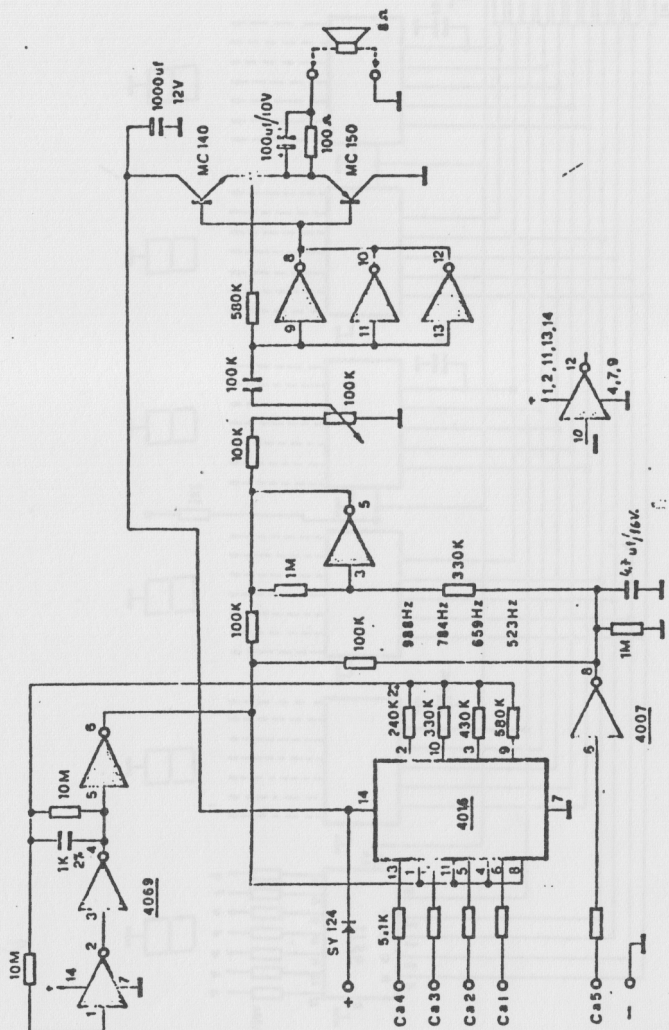

PLAYMATIC

PIN-BALL MACHINE  
SPACE LIGHTS  
CONTROL BOARD SCHEMATIC

DIBUJADO   
COMPROBADO

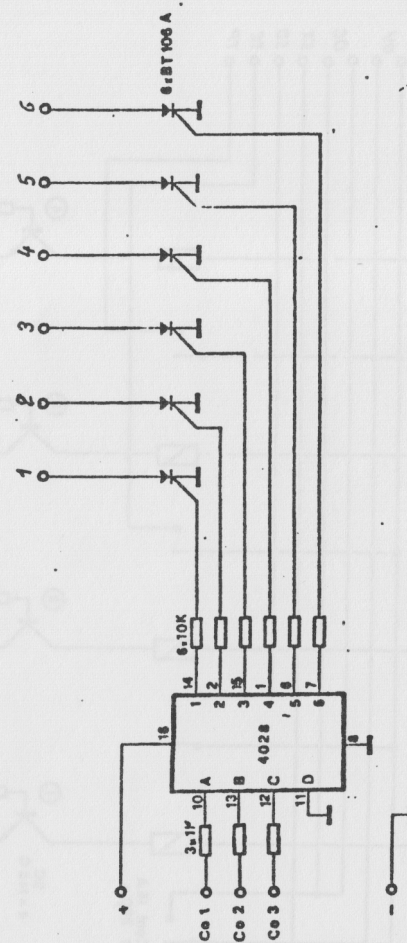





B = bumper  
 T = swinging target  
 F = flipper

P = contact kicker  
 S = mushroom bumper

LITES

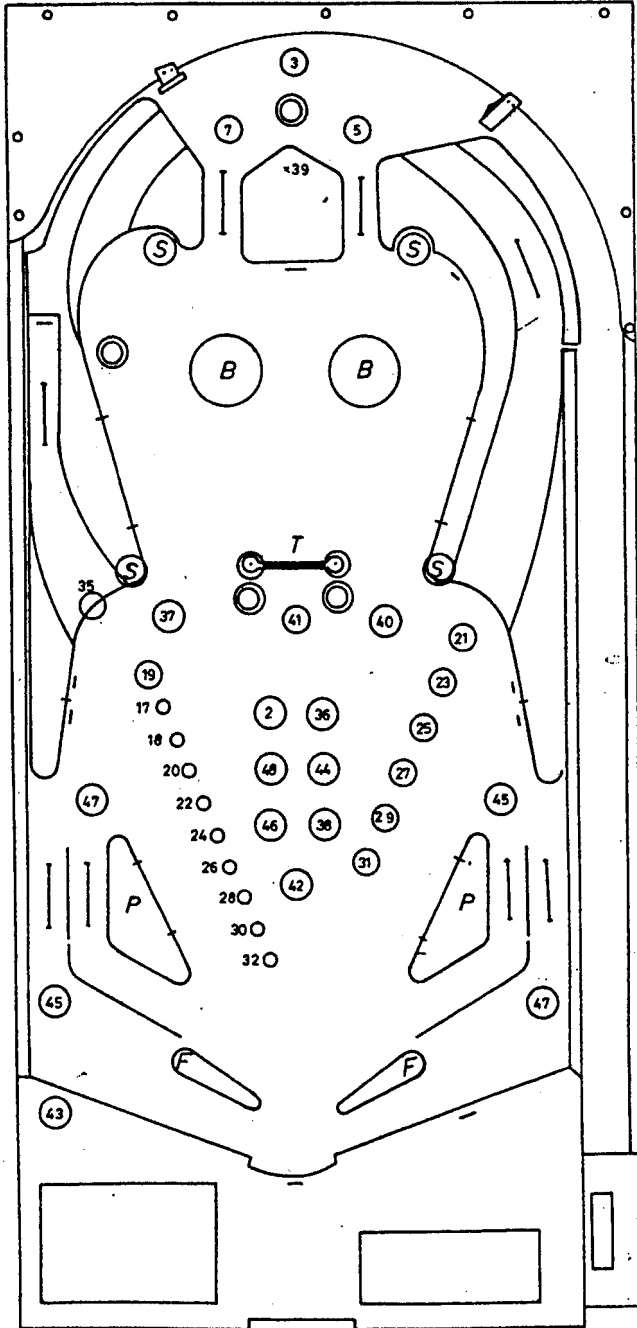

B = bumper  
 T = swinging target  
 F = flipper

P = contact kicker  
 S = mushroom bumper

SWITCHES

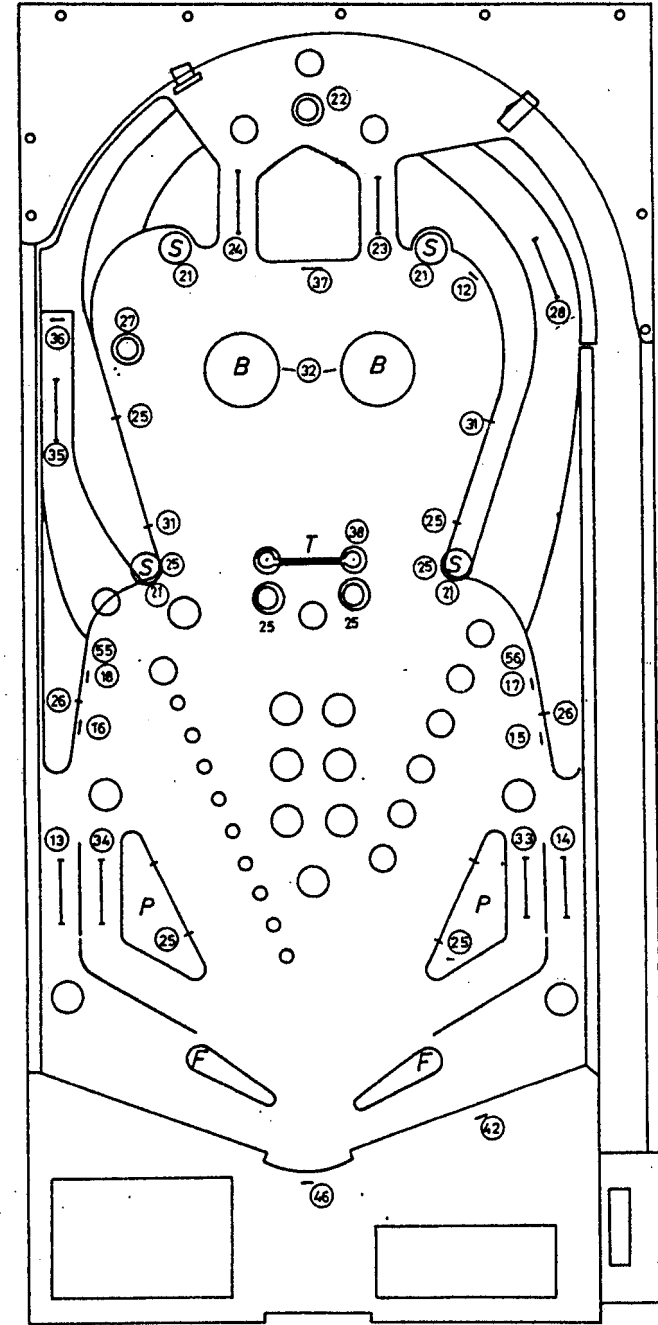

PLAYMATIC

PIN-BALL MACHINE  
RELAYS CONTROL BOARD SCHEMATIC

DIBUJADO   
COMPROBADO

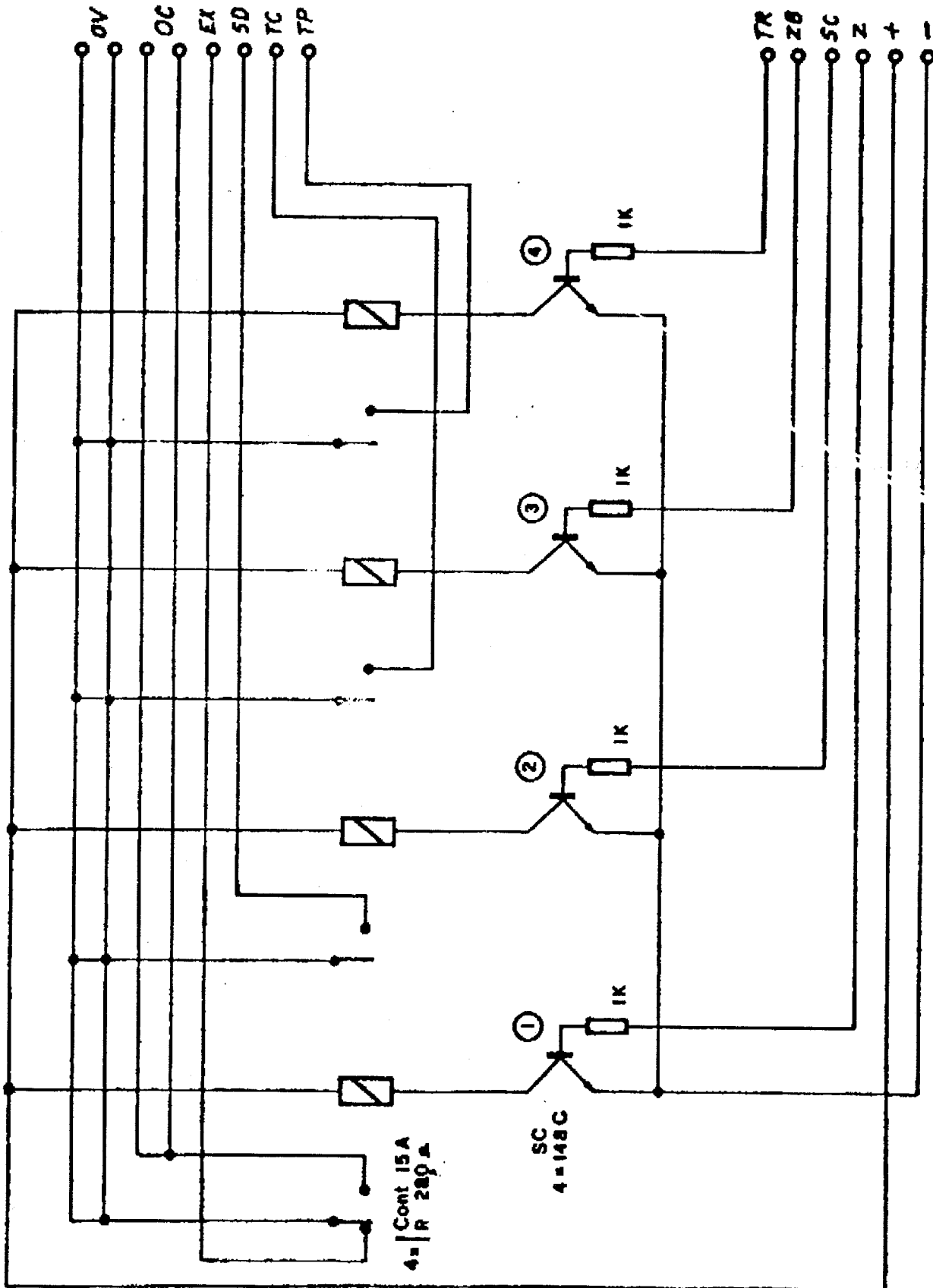

PLAYMATIC

PIN-BALL MACHINE  
DISPLAY DRIVER ASSYS.  
CONTROL BOARD SCHEMATIC

DIBUJADO   
COMPROVADO

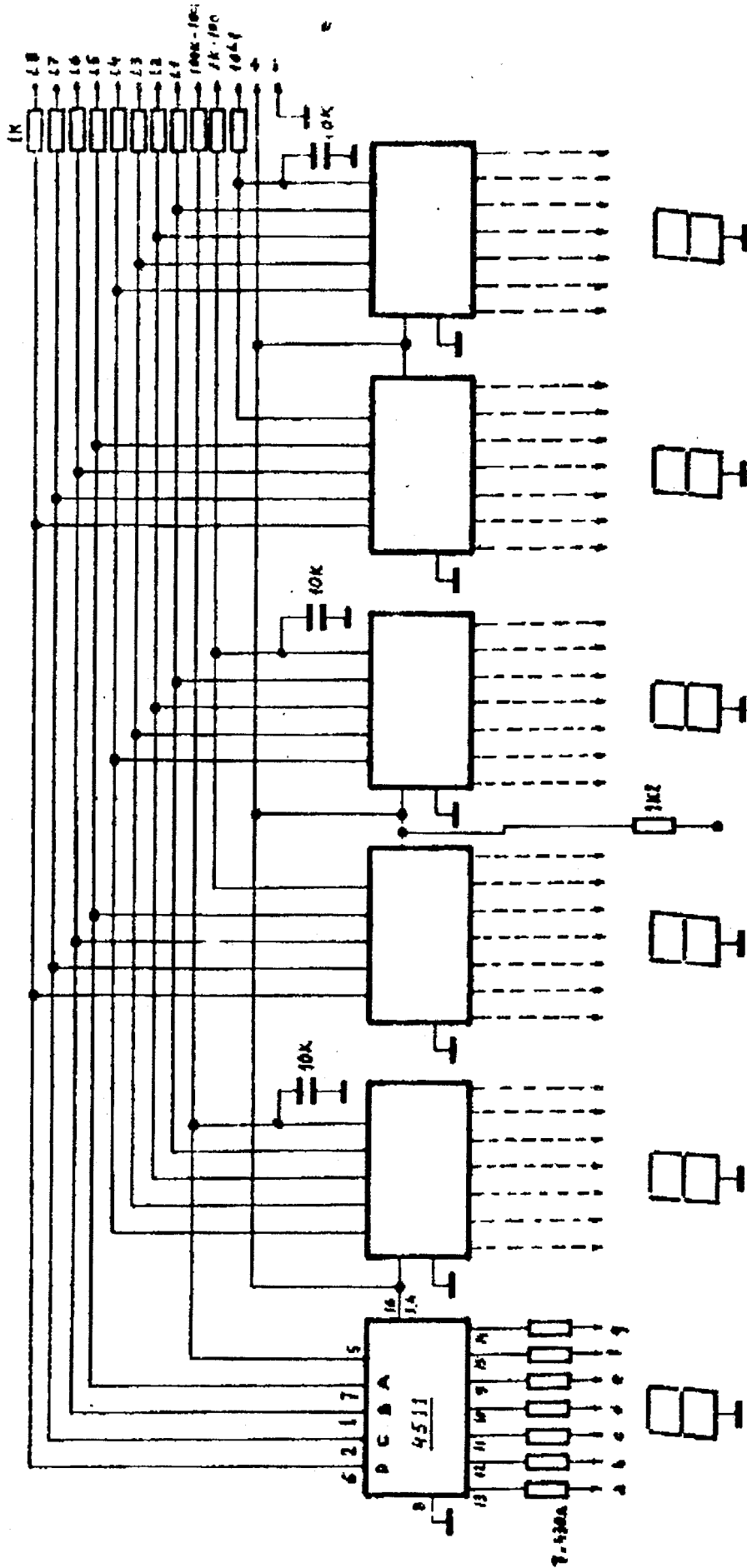

PLAYMATIC

PIN-BALL MACHINE  
**THYRISTORS**  
CONTROL BOARD SCHEMATIC

DIBUJADO   
COMPROBADO

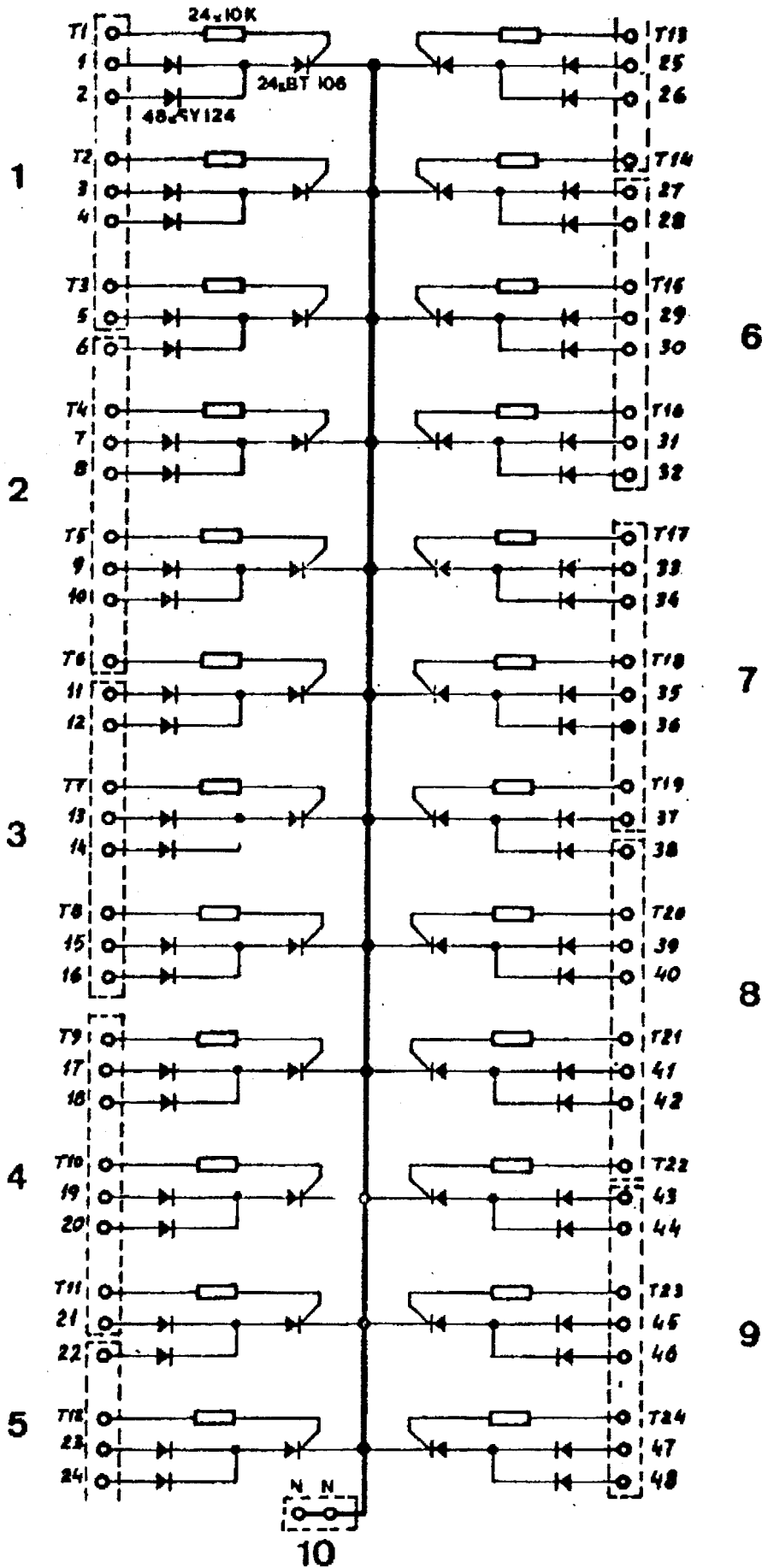



PLAYMATIC

PIN-BALL MACHINE  
SOUND  
CONTROL BOARD SCHEMATIC

DISEÑADO   
COMPROBADO

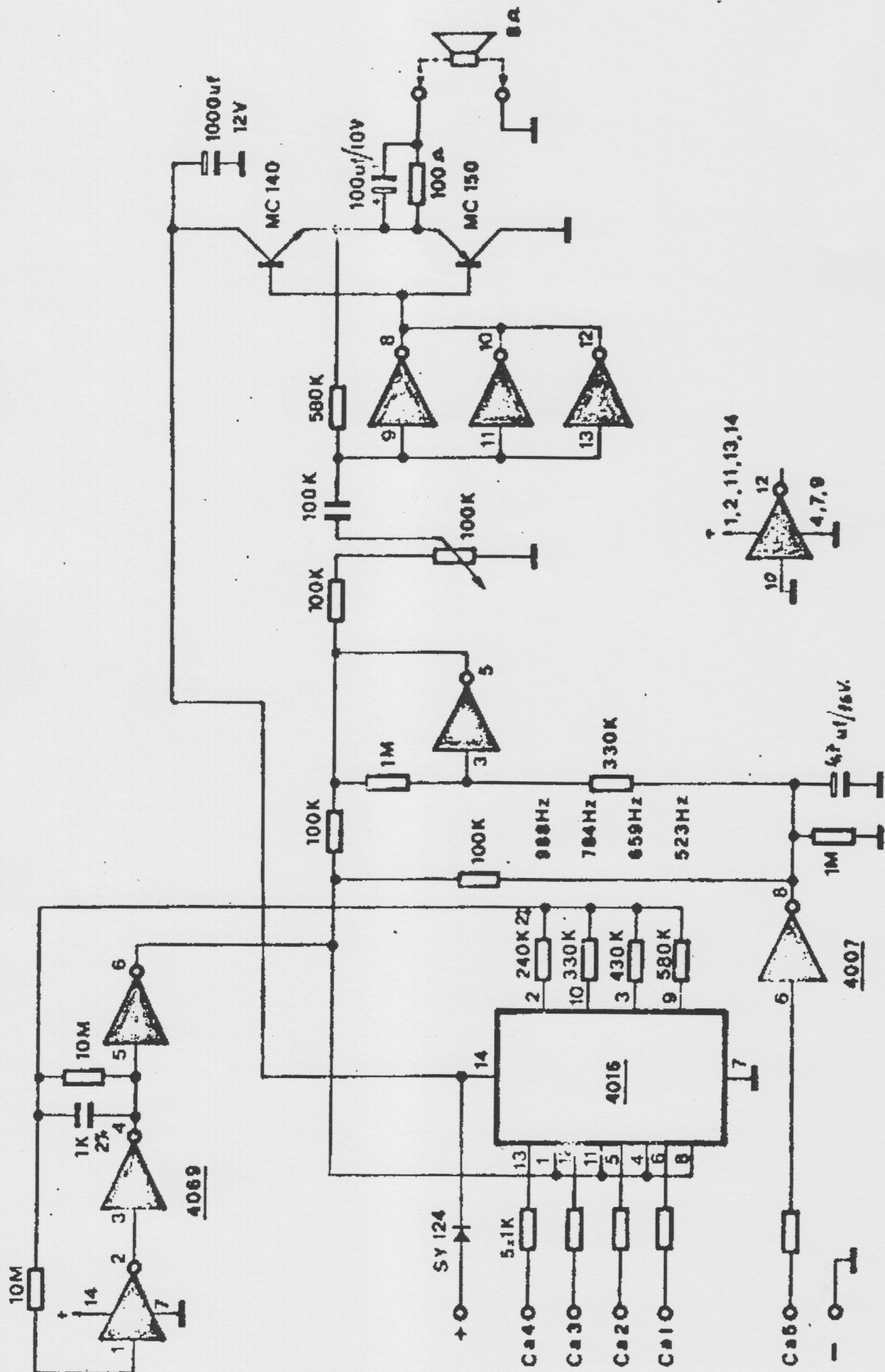



1-5-77 F. Yogo  
25-7-77 F. Caudel

# PLAYMATIC

PIN-BALL MACHINE  
MPU CONTROL BOARD SCHEMATIC

SERIE

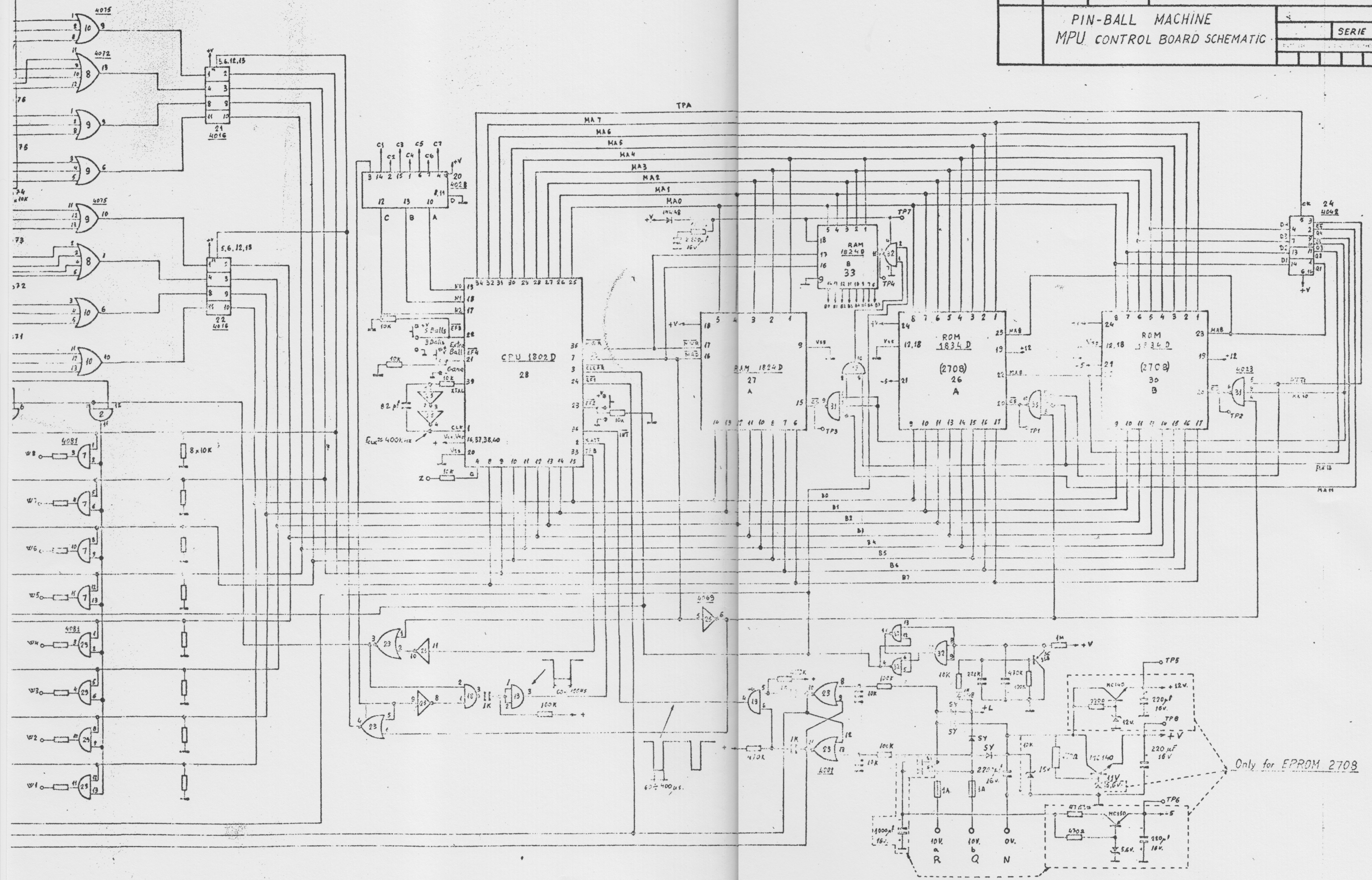

Only for EPROM 2708



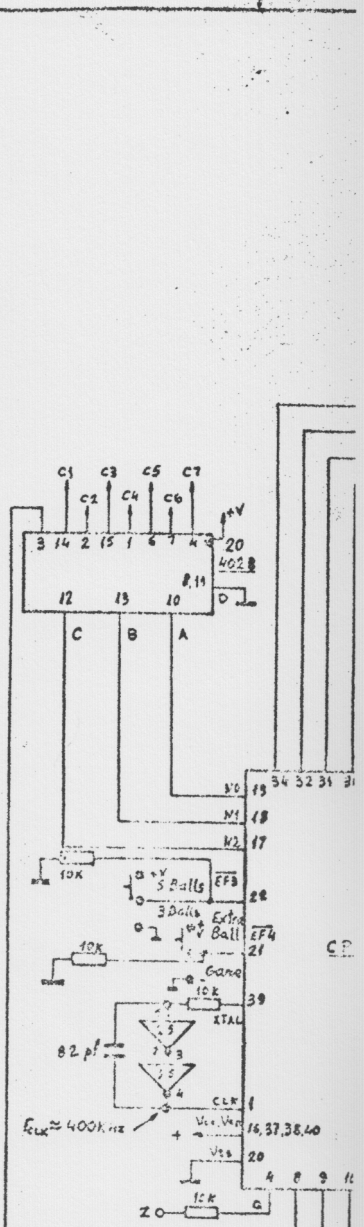
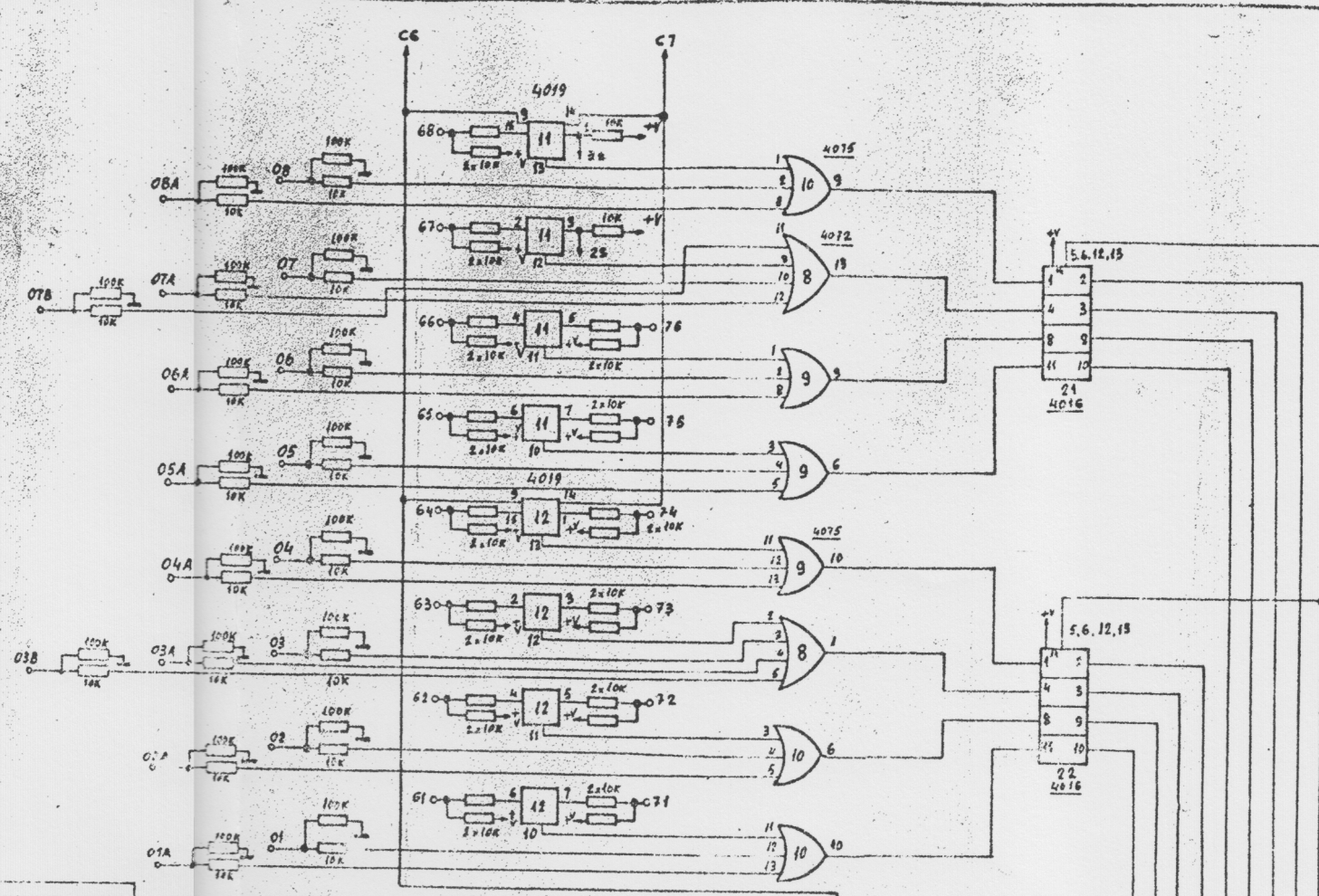
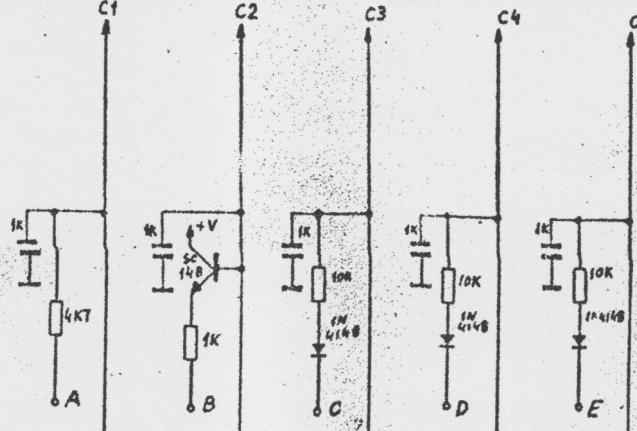

Module Driver MATCH & GAME Display

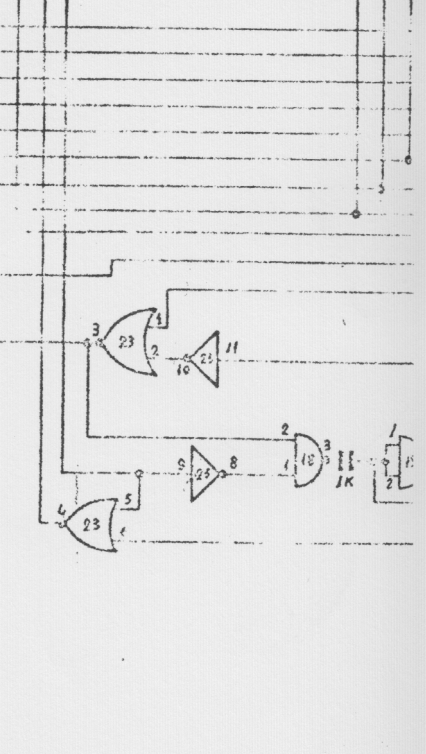
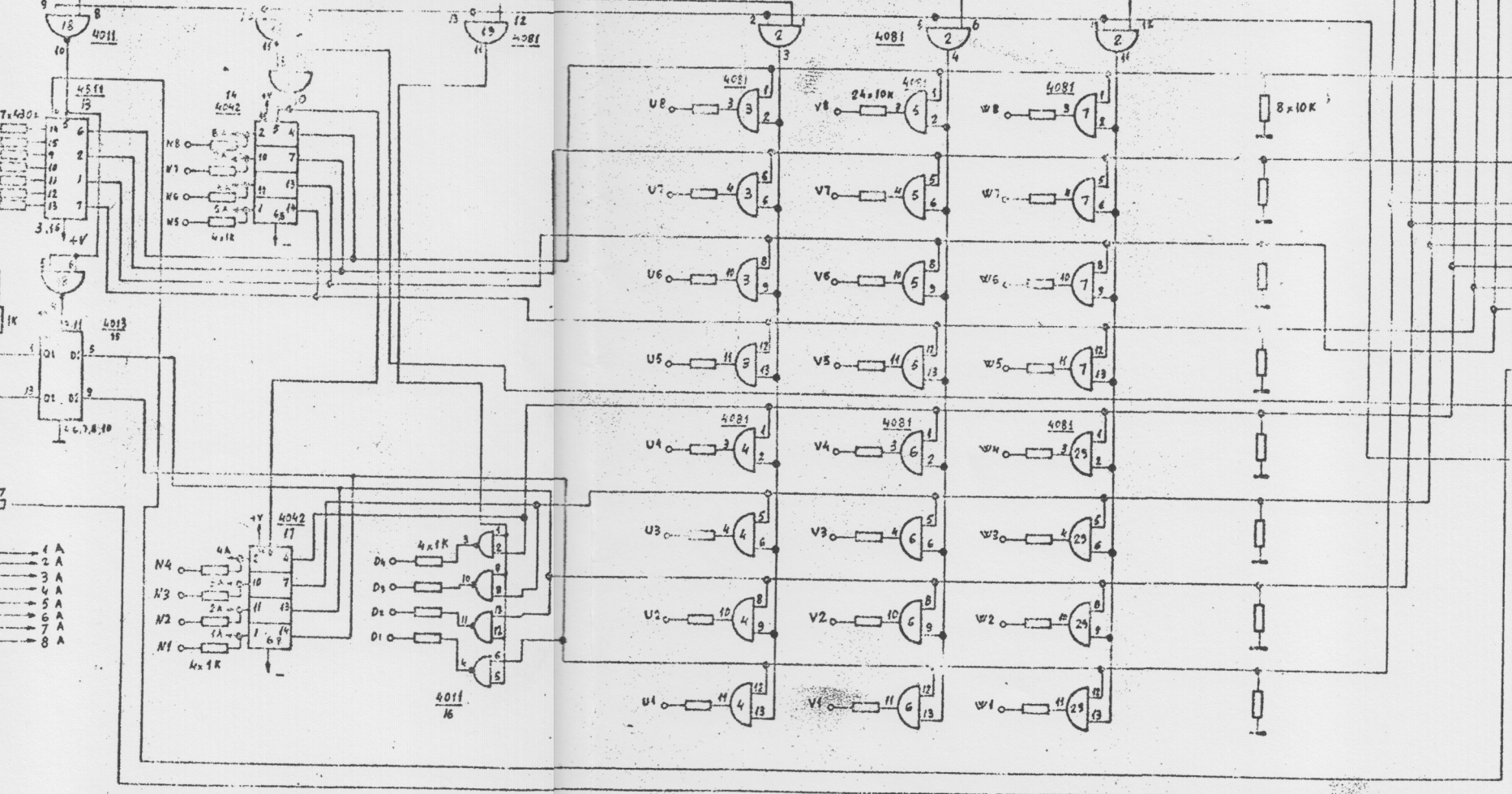
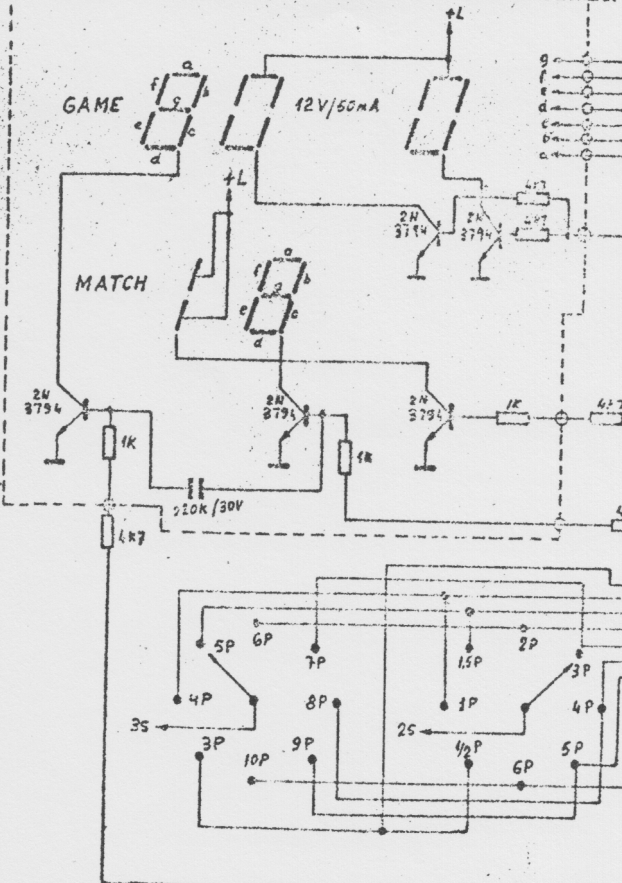





# DISPLAYS 1st

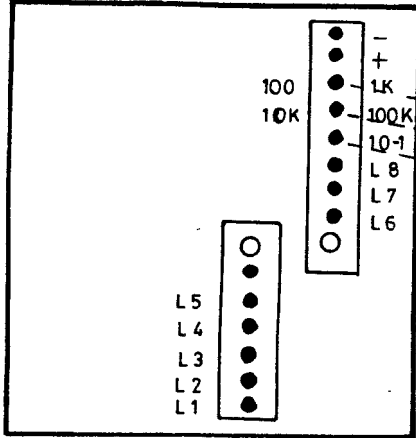

# DISPLAYS 2nd

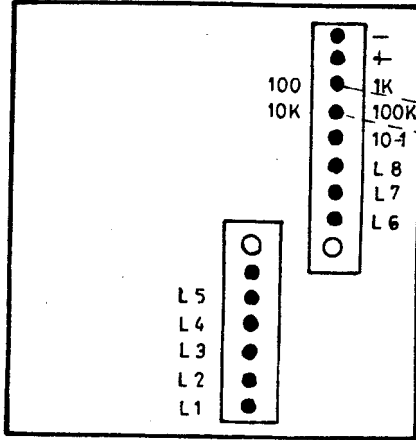

# DISPLAYS 3rd

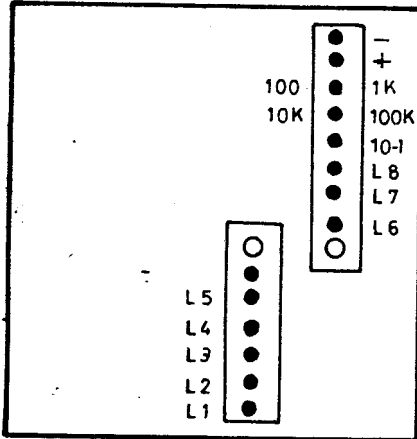

# DISPLAYS 4th

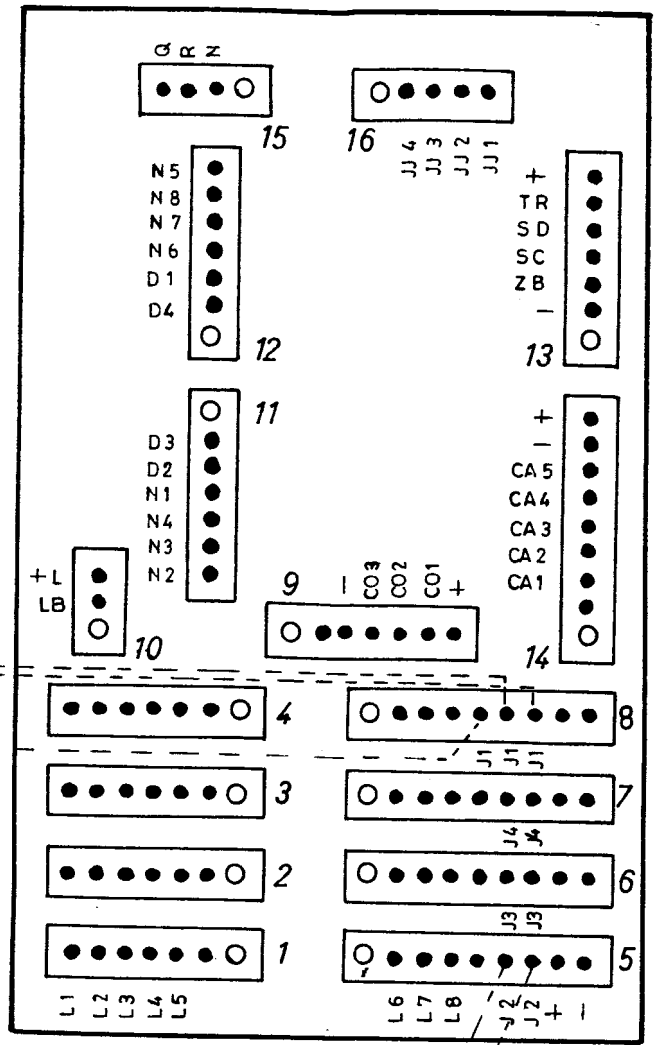
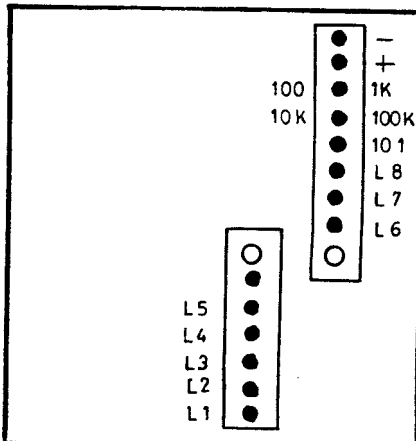

# DECODER

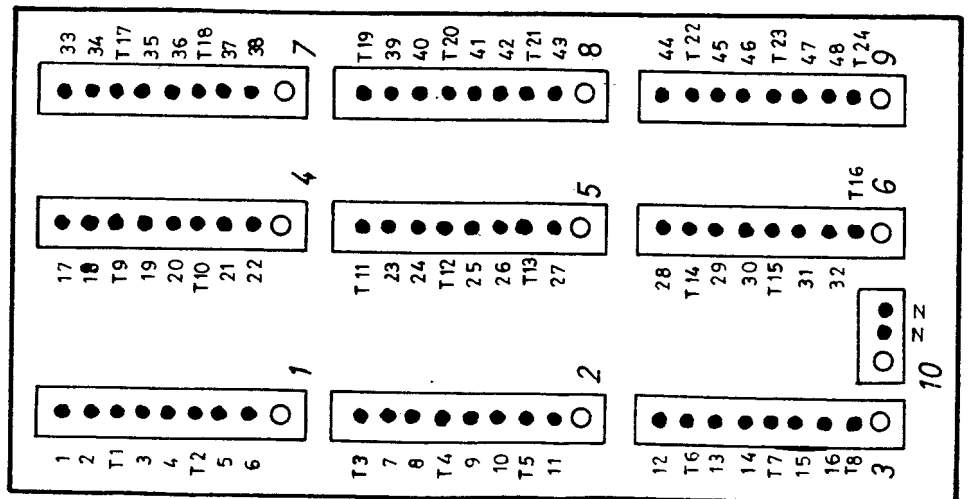

# THYRISTORS

# CODE

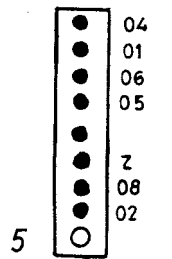
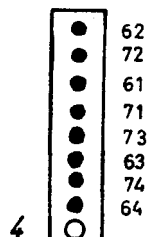
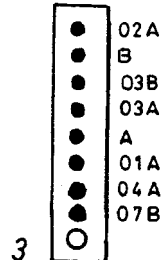
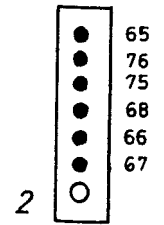
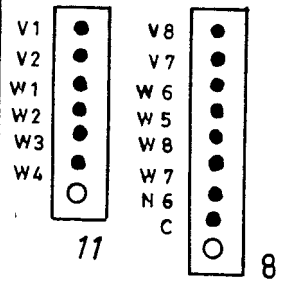
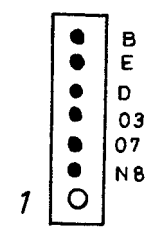
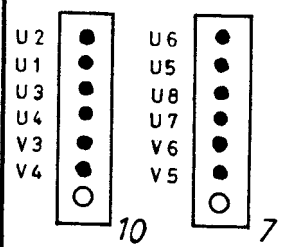
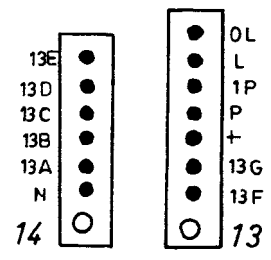
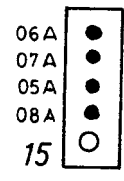
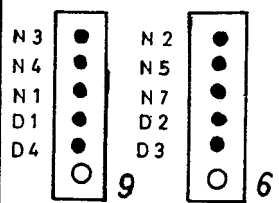

MPU

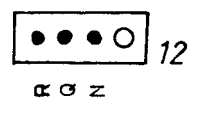

### RELAYS

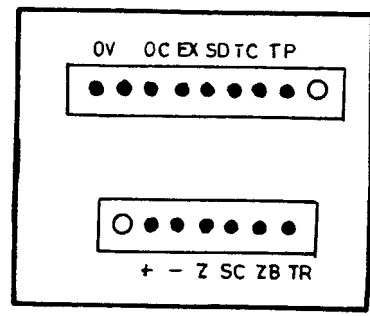

### SOUND

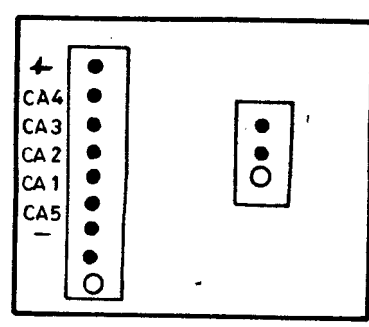

### SPACE LIGHTS

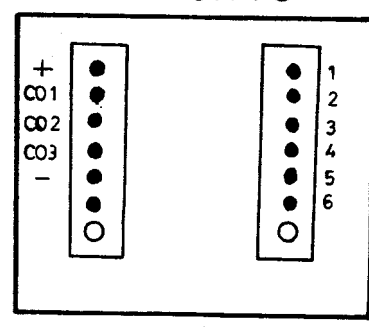

PLAYMATIC S.A.

